



MEI TONG FLYING ALUMINUM
美 通 时 代 铝 业

Guangdong Mei Tong Flying Aluminum Co.,Ltd.

Complete Solutions From **Profiles to Perfection**
High-end **Windows and Doors**

🌐 www.mtflying.com

✉ service@mtflying.com

📍 MA'AN GANG INDUSTRIAL ZONE, SHISHAN TOWN,
NANHAI DISTRICT, FOSHAN CITY, GUANGDONG PROVINCE,
CHINA 528000

ABOUT US

Establishment and Base

Our one-stop door and window services include custom design, material processing, and installation. Source profiles, equipment, and hardware directly from us, and let our experts solve any issues—all under one roof.

Project Cases

Our project footprints extend across multiple countries, showcasing our global reach and diverse applications.

Service Scale

We have served over 200,000 families with our window and door solutions.



MEI TONG FLYING ALUMINUM
美 通 时 代 铝 业

130,000m²

In global manufacturing facilities

200,000+

Million sets of products produced annually

20+

Years of experience in design and manufacturing

2000hours

Salt spray test for unique handle surface treatment-M treatment

30+

Countries choose us

20years

Hardware Warranty

15Types

of rigorous special experimental tests

20+

windows and doors hardware systems

SIX-EVENT ALL-AROUND

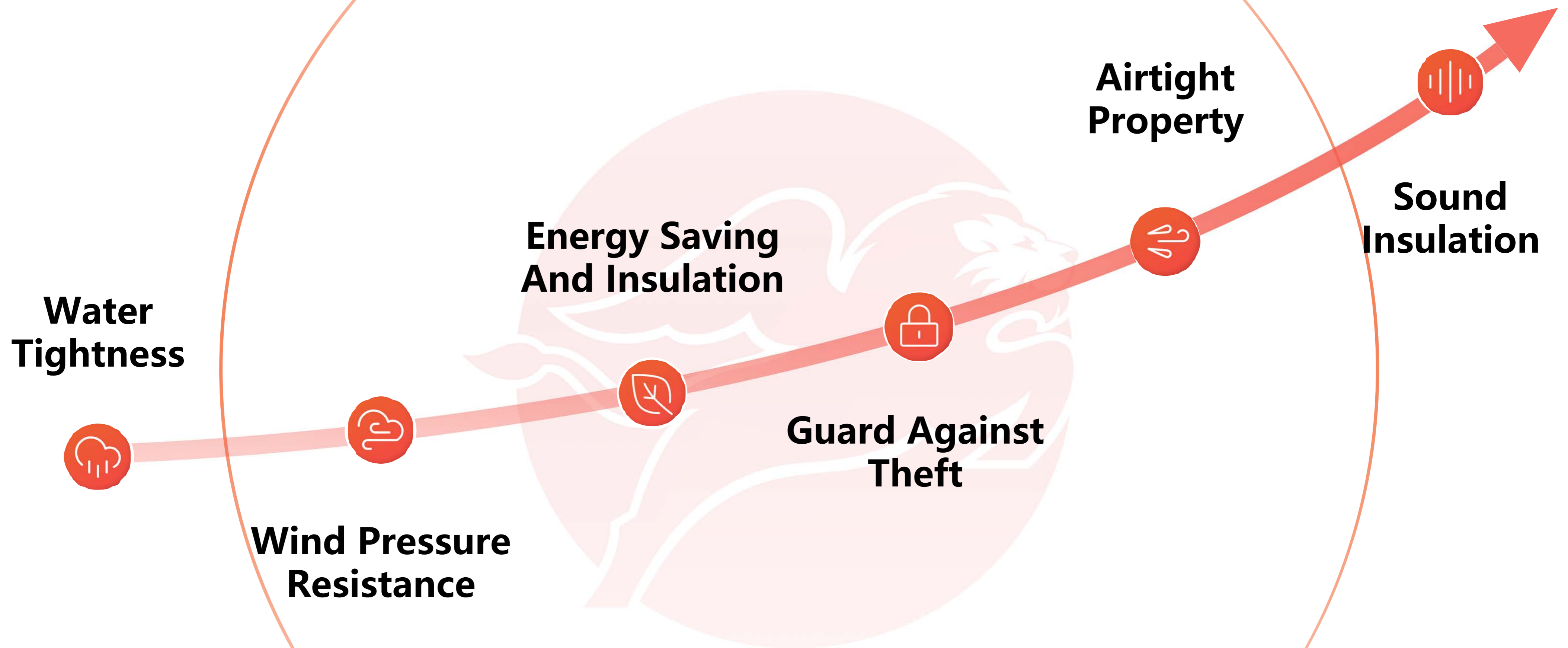

PRODUCT STRENGTH

Product innovation is our core focus.

We invest heavily in R&D and have built a robust patent portfolio across production, materials, design, and functions, covering the whole product lifecycle.

HONOR AND PATENTTE CERTIFICA

- 20 years of craftsmanship, casting international brands
- Obtained European Union CE certification, NFRC, American Standard AAMA certification, Australian Standard AWAcertification, Chinese SGS certification, German IFT and many other international certifications



CUSTOMER SERVICE PROCESS FLOW

With our professional team, we offer custom profiles and window design services to precisely match customer needs.





We innovatively adopt a delivery model based on actual installation quantities, reducing clients' inventory pressure and capital occupation.

Whether for residential, commercial projects, or industrial applications, we provide high-quality products and services, becoming a reliable partner for your business.

Step1 Initial Communication Phase

 Customer Inquiry > Requirement Confirmation >  Preliminary Quotation

Step2 Order Execution Phase

 Contract Signing >  Advance Payment Confirmation >  Professional Door & Window Design
>  On-site Measurement Service >  Production Scheduling

Step3 Production & Quality Control Phase

 Manufacturing >  Quality Inspection > Factory Acceptance

Step4 Logistics & Delivery Phase

 Packaging & Shipping >  Customs Clearance >  Delivery & Receipt

Step5 On-site Support Phase

 Installation Guidance > Customer Acceptance >  After-sales Service

Step6 Long-term Relationship Maintenance

 > Requirement Updates >  Repeat Cooperation

SYSTEM WINDOW SERIES





MULTIPLE OPENING METHODS

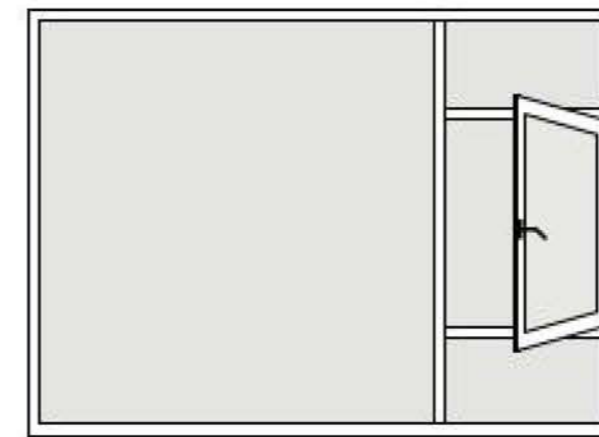

Open Inward

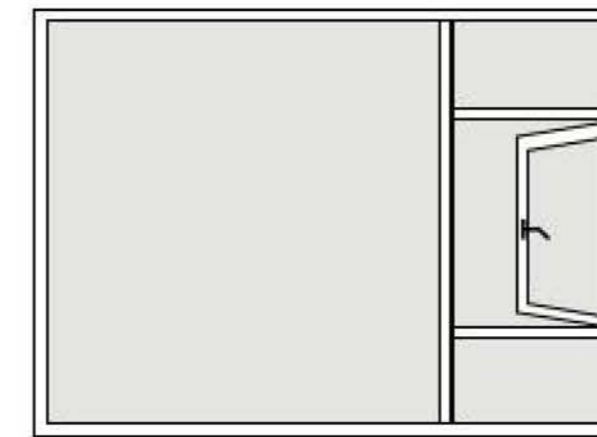

Open Out

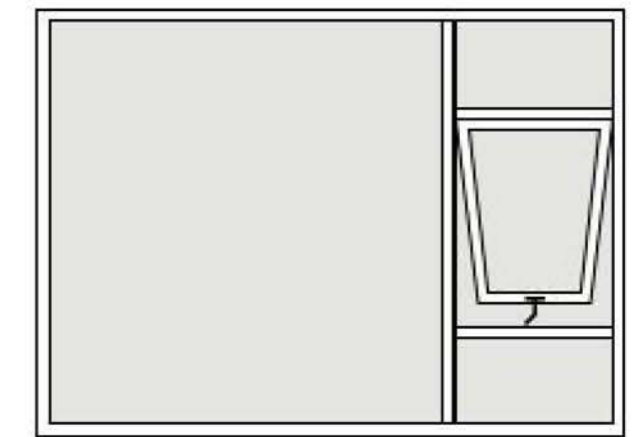

Bottom-Hung

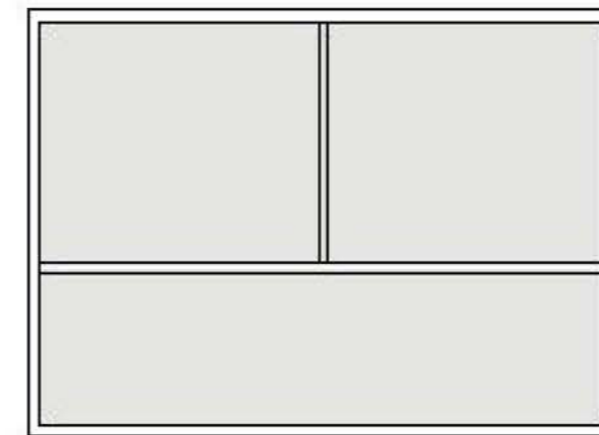

Sliding

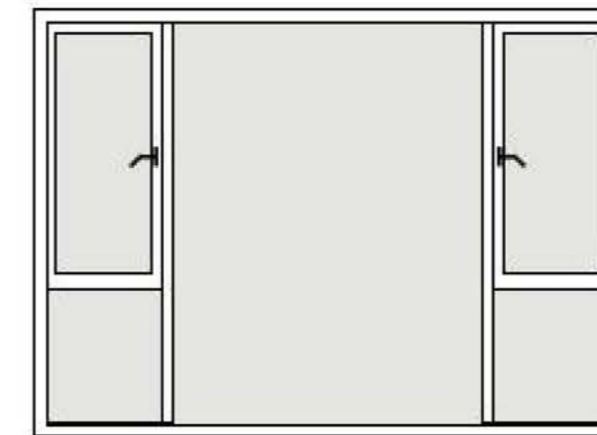

Fixed + Flat Open

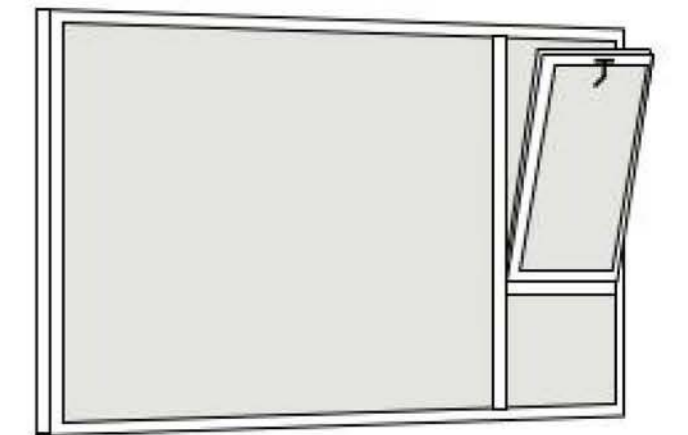

Tilt and Turn

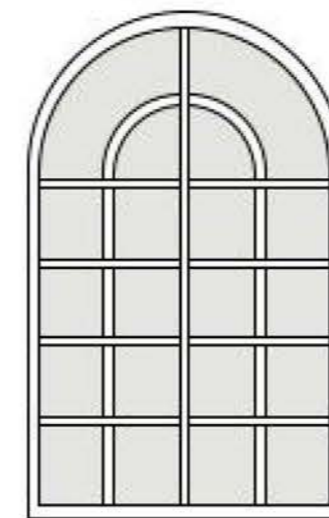

Radiusa

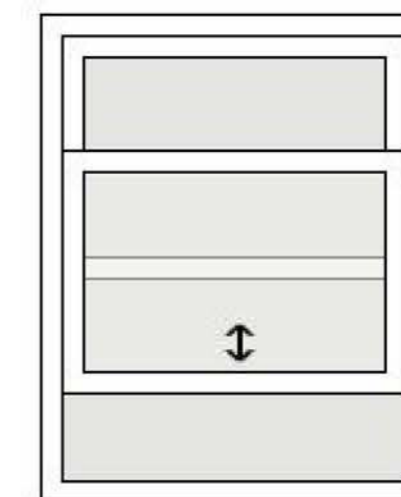

Single Hung

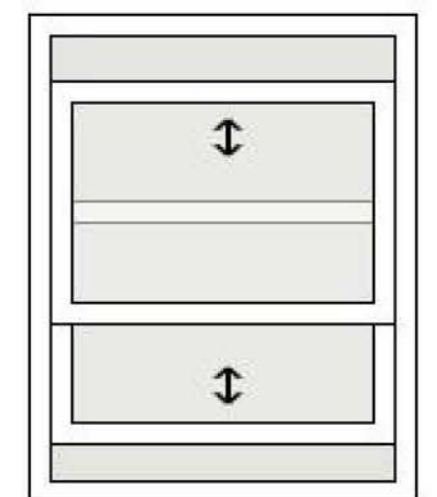

Double Hung

Special design style to create different home atmospheres and discover unexpected beauty,
Both function and beauty are emphasized,
with a narrower border, a more minimalist appearance, and a delicate touch.

E-110

CASEMENT WINDOW



PRODUCT PARAMETER

Profile Wall Thickness

2.0 mm

Frame Width

110 mm

Opening Options

Outward Swing / Inward Swing / Inward Tilt & Swing / Swing Door

STANDARD CONFIGURATION

Profile Configuration

National Standard 6063-T5 Aluminum Alloy

Glass Configuration

5+20A+5mm Tempered Insulated Glass

Hardware System

CMECH Hardware

Shading System

Glass Blinds / Windproof Roller Blinds

Thermal Barrier

PA66 Nylon Thermal Break

Optional Glass Types

LOW-E / Coated / Smart / Tinted Glass

Screen Mesh

0.45 High-Definition Mesh

E-110

CASEMENT WINDOW



BUILDING A REASONABLE SENSE OF ORDER FOR MINIMALISM
WITH SIMPLE YET EXTRAORDINARY DETAILS
CREATING EVERY BIT OF BEAUTY IN LIFE



E-120

CASEMENT WINDOW



PRODUCT PARAMETER

Profile Wall Thickness

2.0 mm / 5.0mm

Frame Width

120mm

Opening Options

Outward Swing / Inward Swing / Inward Swing with Tilt / Swing Door

STANDARD CONFIGURATION

Profile Configuration

National Standard 6063-T5 Aluminum Alloy

Glass Configuration

5+20A+5mm Tempered Insulated Glass

Hardware System

CMECH Hardware

Shading System

Glass Blinds / Windproof Roller Blinds

Thermal Barrier

PA66 Nylon Thermal Break

Optional Glass Types

LOW-E / Coated / Smart / Tinted Glass

Screen Mesh

0.45 High-Definition Mesh

E-120

CASEMENT WINDOW



S-90

CASEMENT WINDOW



PRODUCT PARAMETER

Profile Wall Thickness

1.8mm

Frame Width

90mm

Opening Options

Inward Swing, Double Inward Swing, Inward Swing with Tilt Turn

STANDARD CONFIGURATION

Profile Configuration

National Standard 6063-T5 Aluminum Alloy

Glass Configuration

Triple Glazing: 5mm + 12A + 5mm + 12A + 5mm

Double Glazing: 5mm + 20A + 5mm

Hardware System

CMECH Hardware

Shading System

Glass Blinds / Windproof Roller Blinds

Thermal Barrier

PA66 Nylon Thermal Break

Optional Glass Types

LOW-E / Coated / Smart / Tinted Glass

Screen Mesh

0.45 High-Definition Screen / Folding Screen Mesh



S-90

CASEMENT WINDOW

DOUBLE INWARD OPENING DESIGN SAFETY FIRST EASY TO CLEAN

Triple-Glass Dual-Chamber Configuration : Featuring a triple-glass setup (5+12A+5+12A+5) and a double-glass option (5+20A+5) , delivering exceptional sound insulation and thermal efficiency.

Featured Imported Hardware
CMECH handle , over tens of thousands of safe openings and closures,
Won the German Red Dot Design Award.

Featured Imported Hardware
CMECH handle , over tens of thousands of safe openings and closures,
Won the German Red Dot Design Award.

Multiple Sealing Strips
Three seal design, equipped with automotive grade EPDM EPDM compound foam rubber strip, the middle duck-bill glue fully play the role of rain curtain principle to make the product has good air tightness and water tightness.

Locks In Rainwater And Prevents Infiltration
Outer Seal with Water-Activated Expansion Strips, Expands upon contact with water, effectively locking out rainwater and preventing leaks.Inner EPDM Glass Seal,highly durable with strong rebound force, ensuring a tight, secure grip on the glass.

112

SLIDING WINDOW



PRODUCT PARAMETER

Profile Wall Thickness

1.4mm

Frame Width

112mm

Opening Options

Push-and-pull

STANDARD CONFIGURATION

Profile Configuration

National Standard 6063-T5 Aluminum Alloy

Thermal Barrier

PA66 Nylon Thermal Break

Optional Glass Types

LOW-E / Coated / Smart / Tinted Glass

Hardware System

EMD System

Glass Configuration

5mm+12A+5mm Tempered Insulated Glass

Shading System

Glass Blinds / Windproof Roller Blinds

Screen Mesh

0.45 High-Definition Screen / Folding Screen Mesh

112

SLIDING WINDOW



IN MODERN LIFE
WE ARE CONSTANTLY IMPACTED BY THE NOISY AND BEAUTIFUL THINGS
FEW PEOPLE CAN TRULY CALM DOWN,
EXPERIENCE THE IMAGINATION AND RELAXATION BROUGHT BY
MINIMALIST LIVING.

123

BROKEN BRIDGE SUSPENSION SLIDING WINDOW



PRODUCT PARAMETER

Profile Wall Thickness

2.0mm

Frame Width

123mm

Opening Options

Push-and-pull

STANDARD CONFIGURATION

Profile Configuration

National Standard 6063-T5 Aluminum Alloy

Thermal Barrier

PA66 Nylon Thermal Break

Glass Configuration

5mm+15A+5mm Tempered Insulated Glass

Optional Glass Types

LOW-E / Coated / Smart / Tinted Glass

Hardware System

EMD system

Screen Mesh

0.45 High-Definition Screen
/ Folding Screen Mesh

Shading System

Glass Blinds / Windproof Roller Blinds

123

BROKEN BRIDGE SUSPENSION SLIDING WINDOW



9mm Ultra-Slim Cable Channel

The linear track design delivers a sleek, seamless visual profile, with the track's groove width minimized to an ultra-compact 9mm.

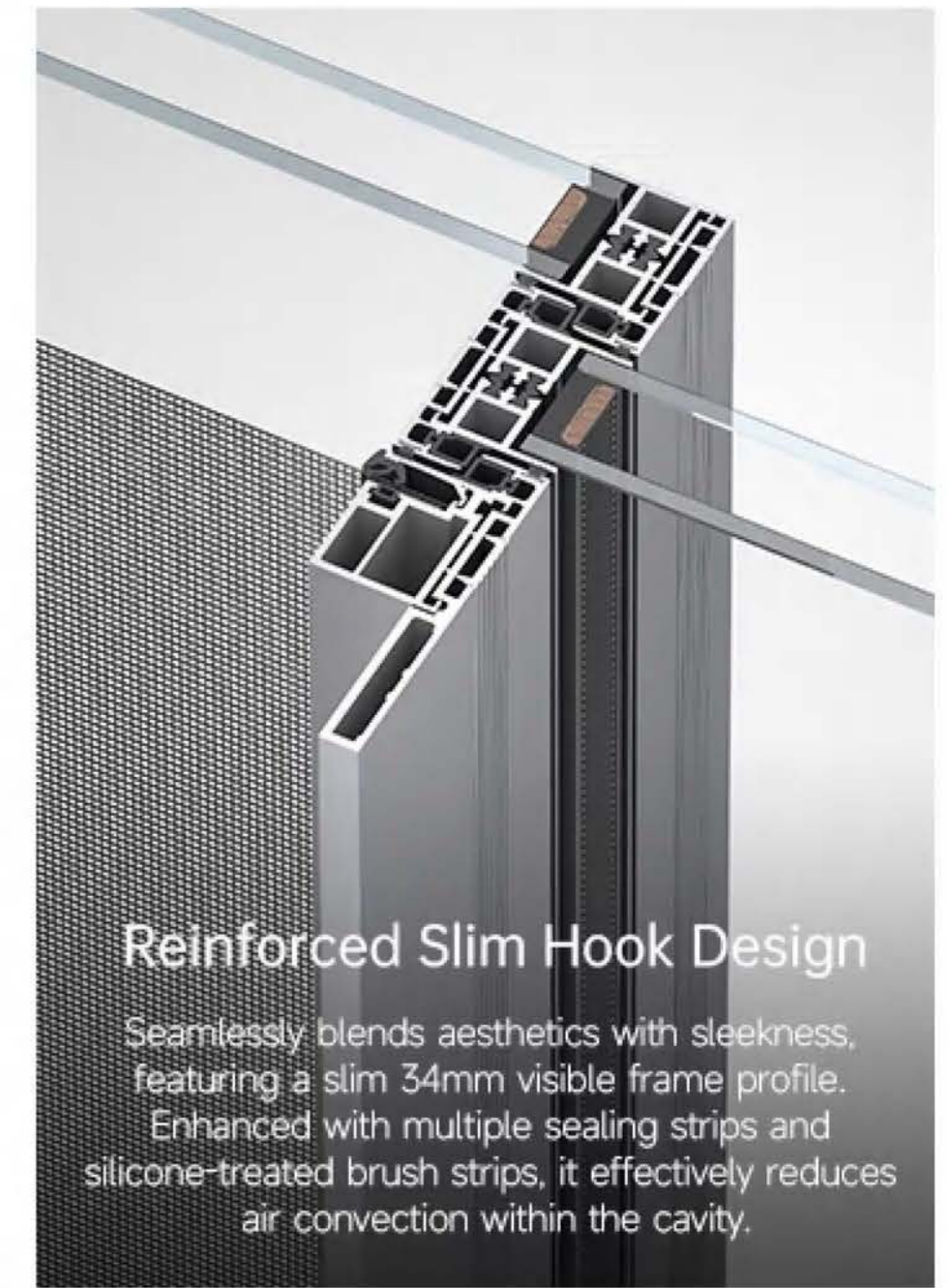

Reinforced Slim Hook Design

Seamlessly blends aesthetics with sleekness, featuring a slim 34mm visible frame profile. Enhanced with multiple sealing strips and silicone-treated brush strips, it effectively reduces air convection within the cavity.

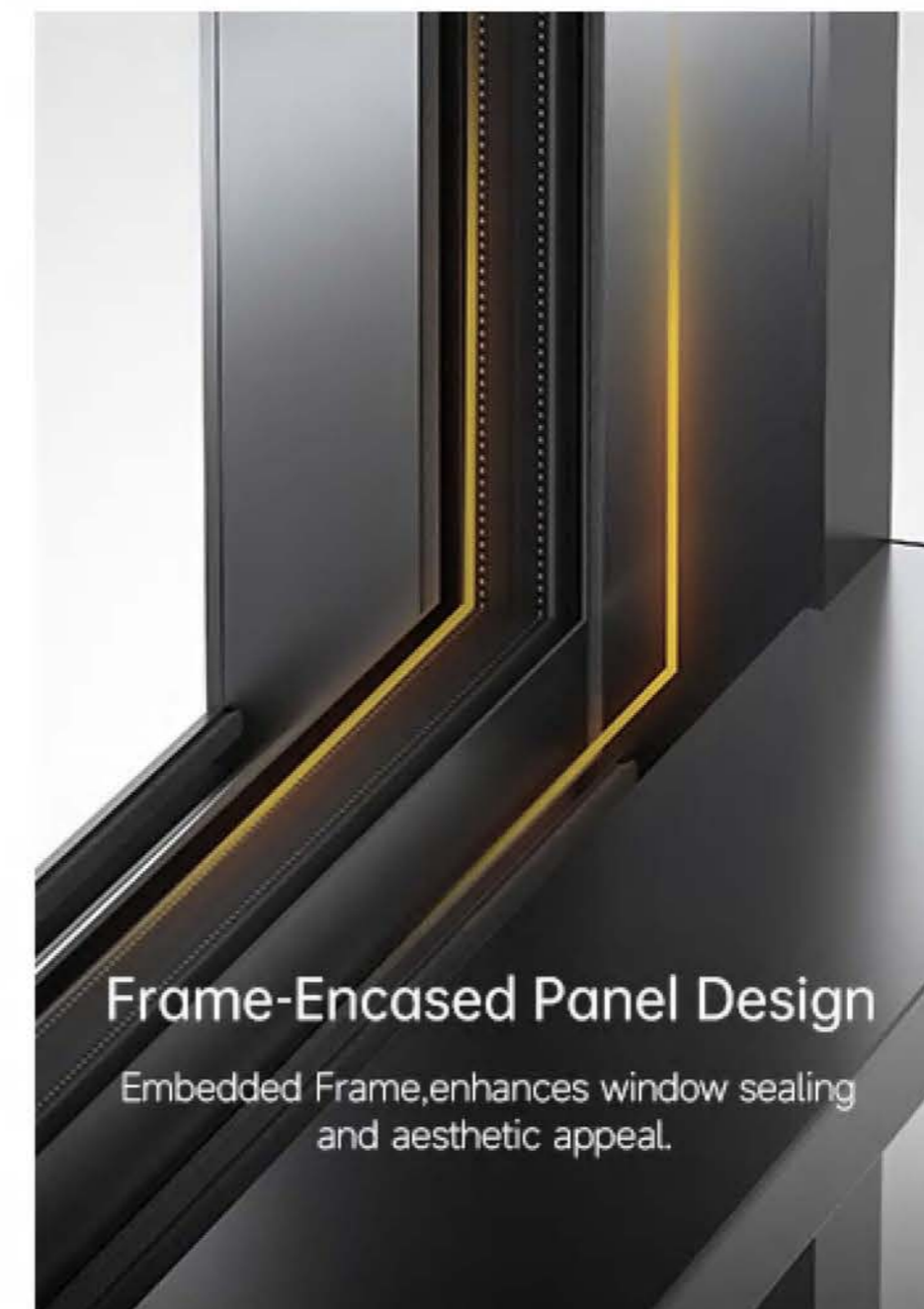

Frame-Encased Panel Design

Embedded Frame, enhances window sealing and aesthetic appeal.

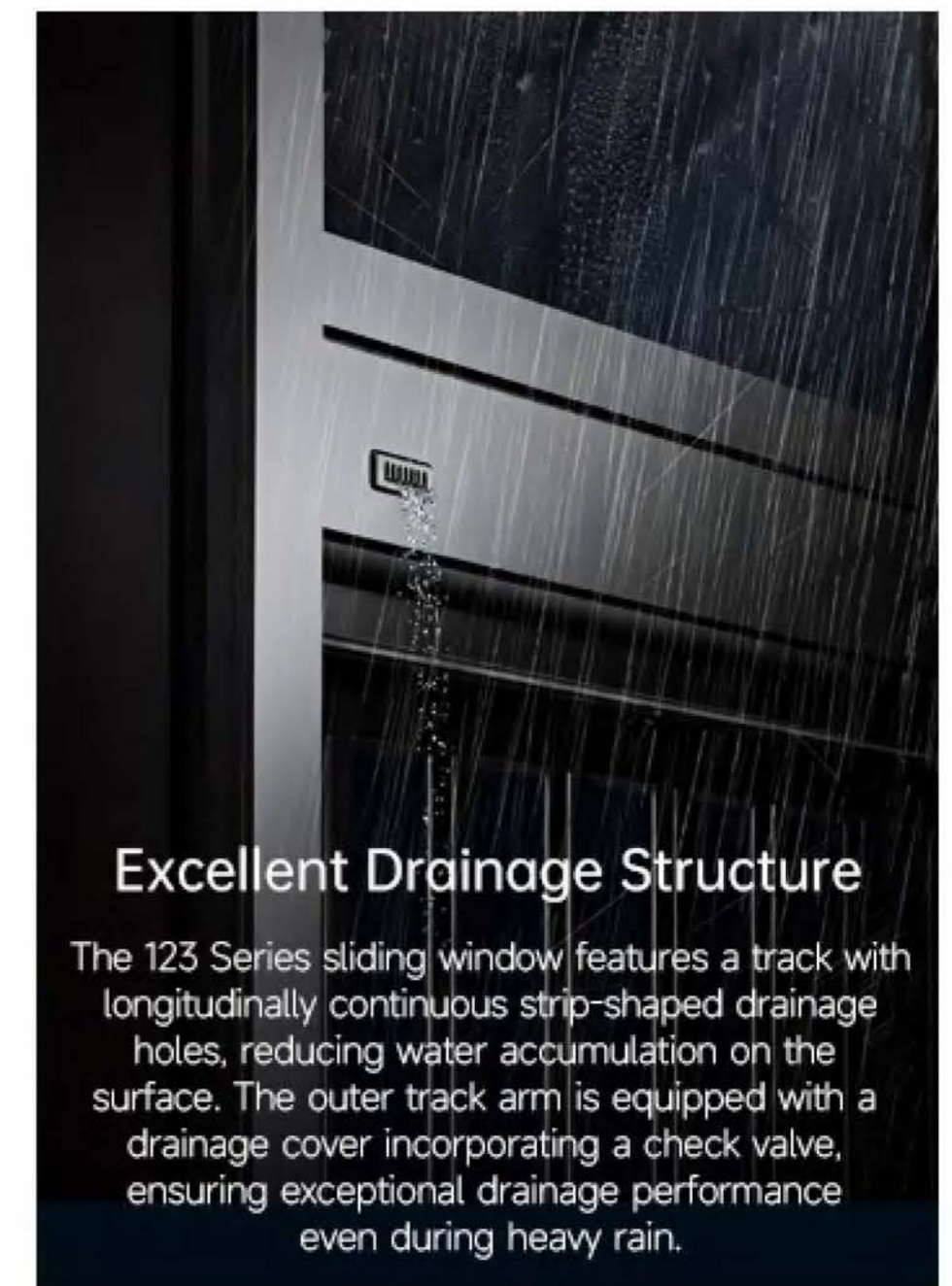

Excellent Drainage Structure

The 123 Series sliding window features a track with longitudinally continuous strip-shaped drainage holes, reducing water accumulation on the surface. The outer track arm is equipped with a drainage cover incorporating a check valve, ensuring exceptional drainage performance even during heavy rain.

130

SIDE-PRESS WINDOW

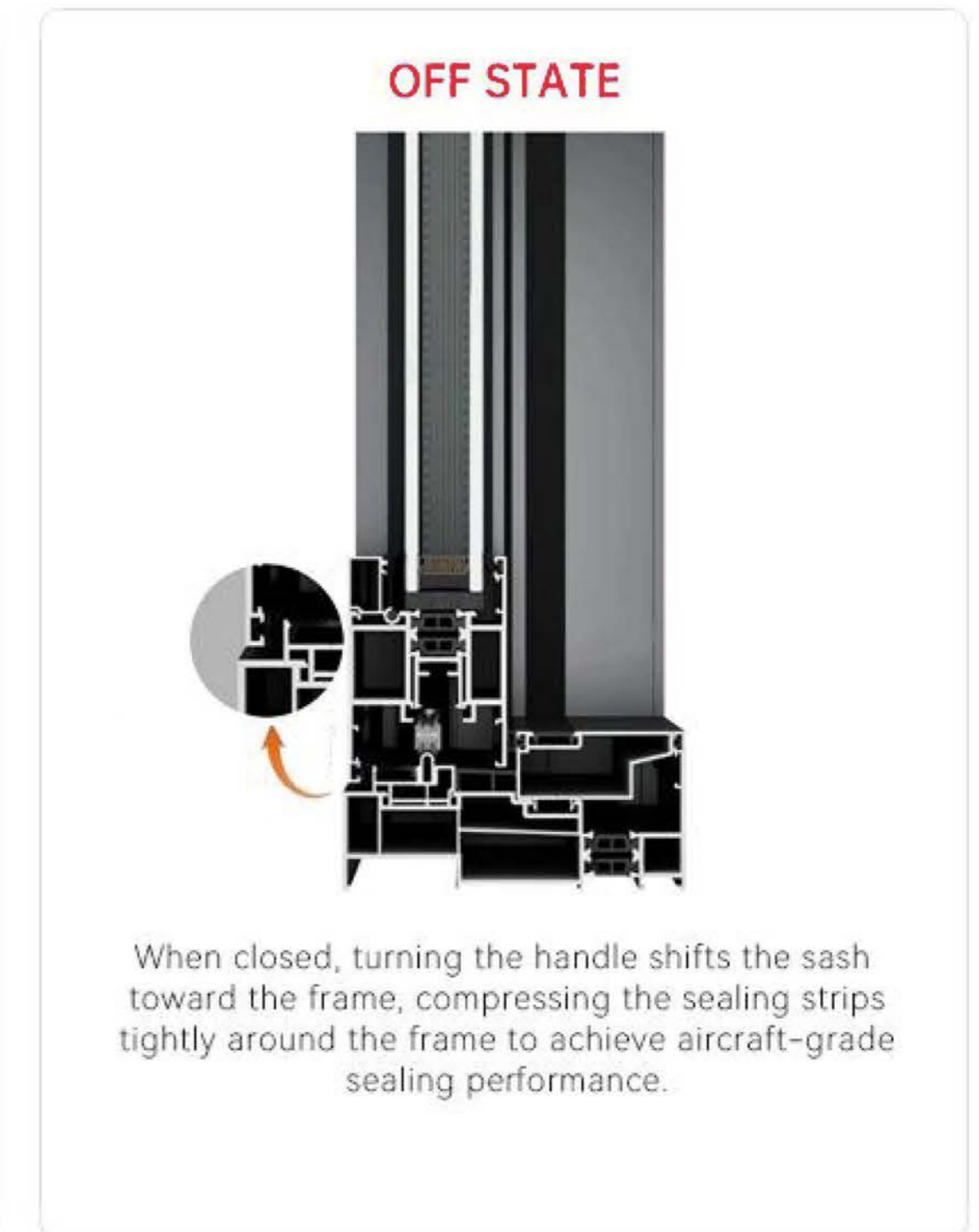
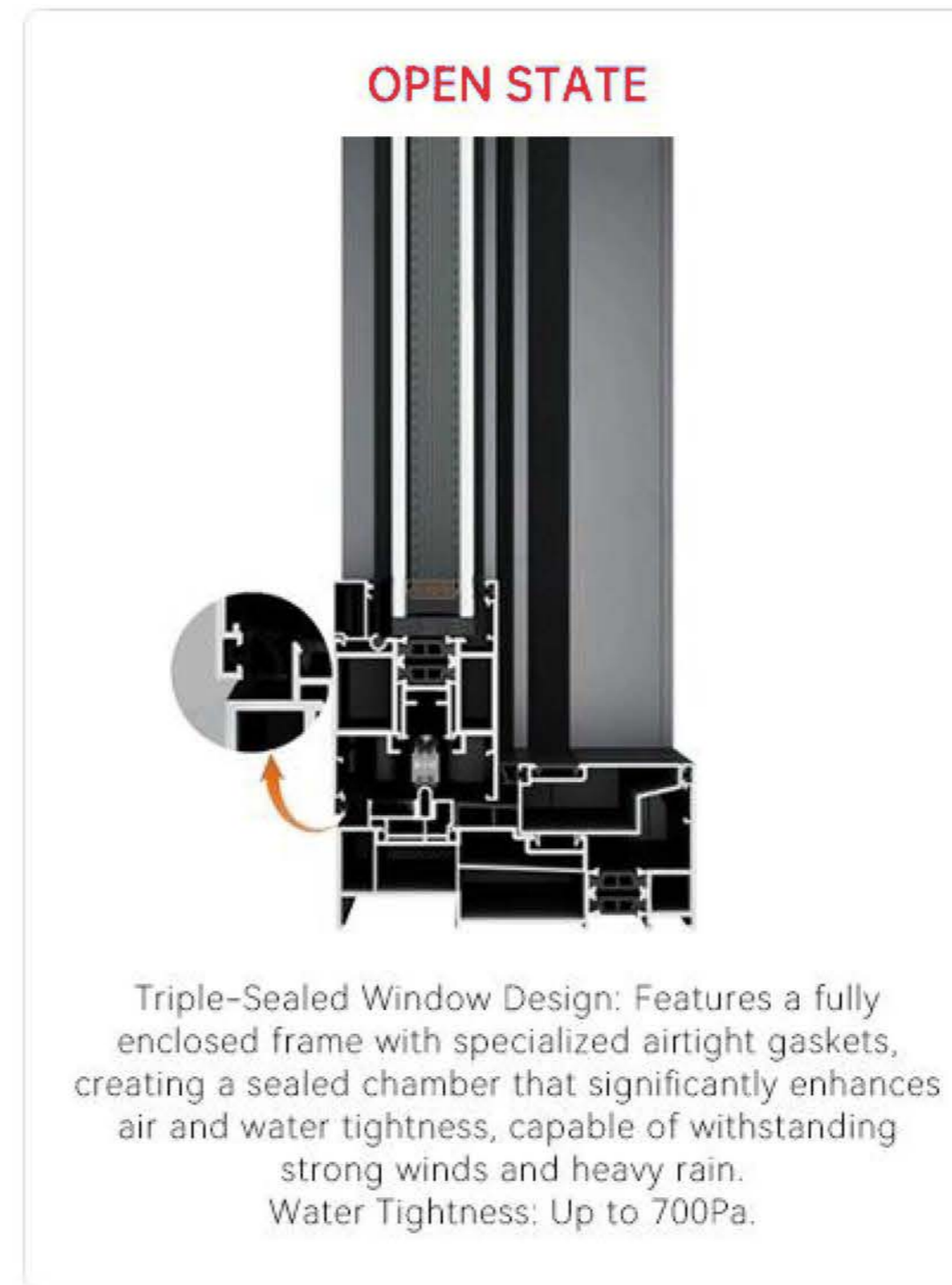

PRODUCT PARAMETER

Profile Wall Thickness

2.0mm

Frame Width

130mm

Opening Options

Push-and-pull

STANDARD CONFIGURATION

Profile Configuration

National Standard 6063-T5 Aluminum Alloy

Thermal Barrier

PA66 Nylon Thermal Break

Glass Configuration

5mm+20A+5mm Tempered Insulated Glass

Optional Glass Types

LOW-E / Coated / Smart / Tinted Glass

Hardware System

EMD system

Screen Mesh

0.45 High-Definition Screen /
Folding Screen Mesh

Shading System

Glass Blinds / Windproof Roller Blinds

130

SIDE-PRESS WINDOW



Sliding Compression

Customizable to Meet User Needs: Supports Both Floor-Mounted and Standard Side-Pressure Options
Operation: Side-pressure sliding with open-swing design, featuring integrated interior pressure lines and glass railings.

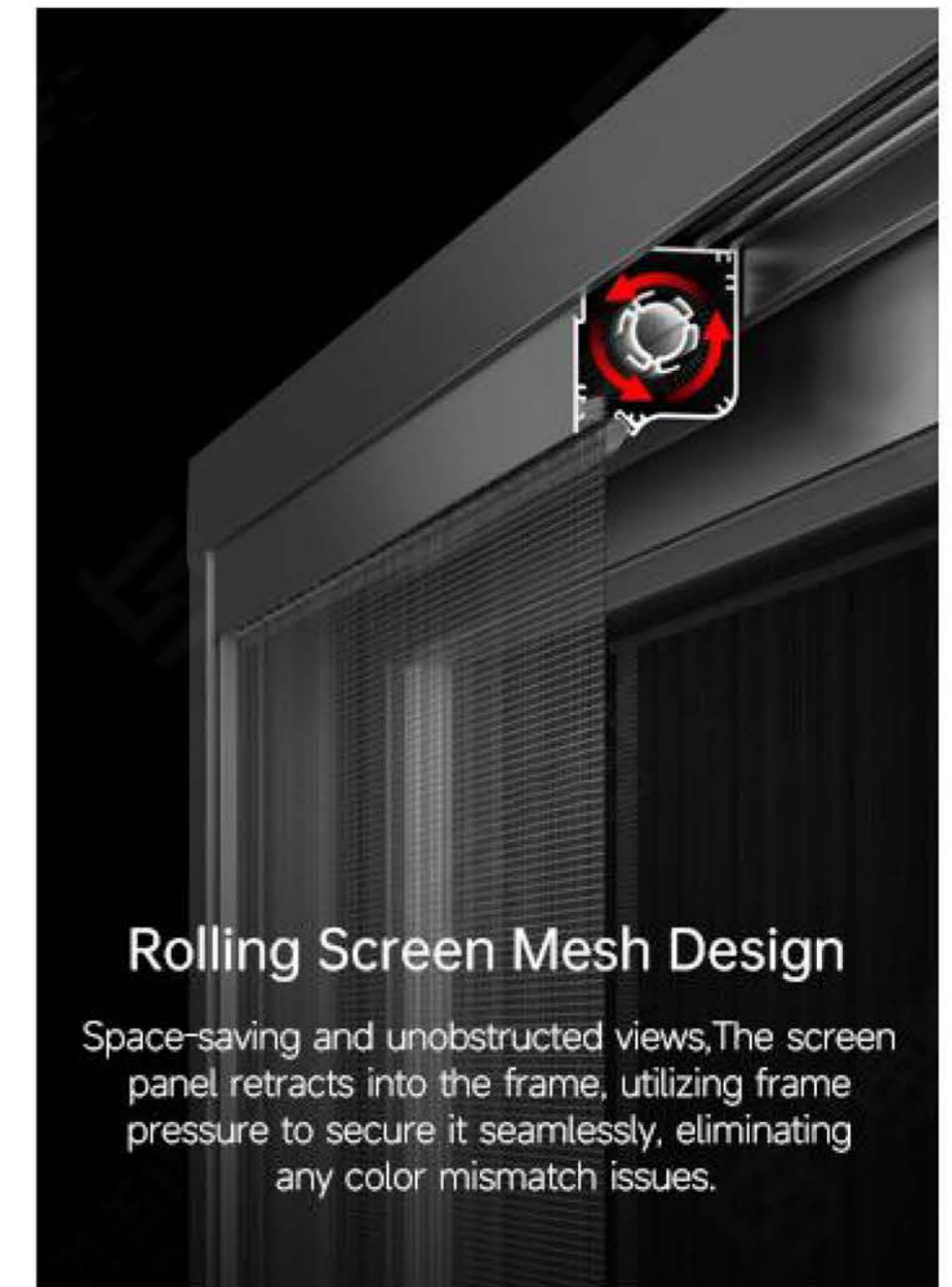

Rolling Screen Mesh Design

Space-saving and unobstructed views, The screen panel retracts into the frame, utilizing frame pressure to secure it seamlessly, eliminating any color mismatch issues.



Enjoy The Scenery

Side Pressure Opening Design



Glass Railing Design with Optional Security Screen Door

Maximized Balcony Space Utilization: Combines stunning aesthetics and functionality, surpassing any window style. Features insect-proof design, exceptional durability, and effortless cleaning.

65

FOLDING WINDOW



PRODUCT PARAMETER

Profile Wall Thickness

2.0 mm

Frame Width

65mm

Single Fan Size Limit

Maximum Width: 700mm
Maximum Height: 2500mm

Opening Options

Push-And-Pull

STANDARD CONFIGURATION

Profile Configuration

National Standard 6063-T5 Aluminum Alloy

Thermal Barrier

PA66 Nylon Thermal Break

Glass Configuration

5mm+20A+5mm Tempered Insulated Glass

Optional Glass Types

LOW-E / Coated / Smart / Tinted Glass

Hardware System

KERSSENBERG

Screen Mesh

0.45 High-Definition Screen / Folding Screen Mesh

65

FOLDING WINDOW

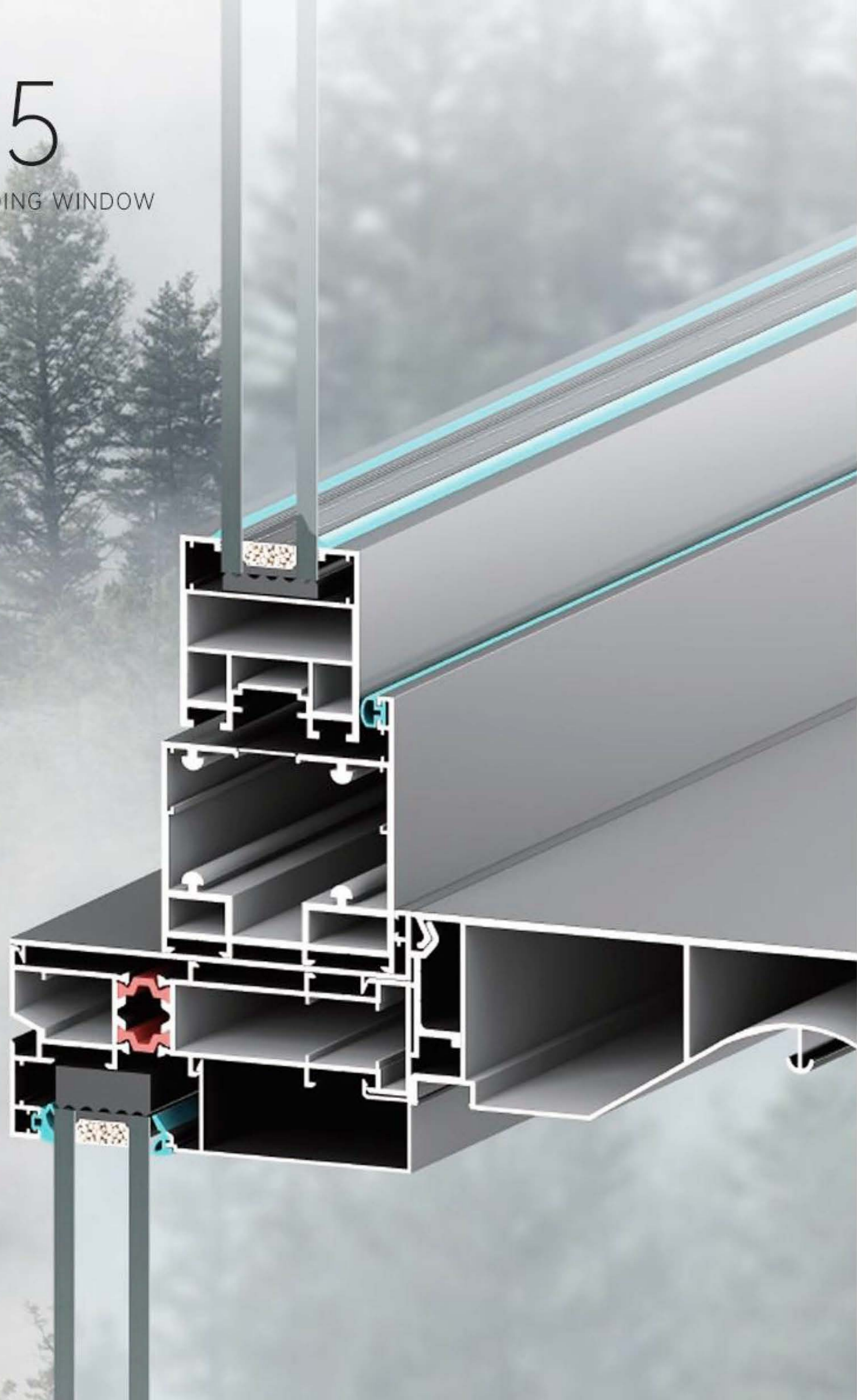

IN THE DEPTHS OF EVERYONE'S HEART
THEY ALL HAVE RICH AND COMPLEX EMOTIONAL WORLDS
AND THE FOLDING WINDOW SERIES OF EMD
JUST LIKE A COLLAGE ART
SPLICING VARIOUS EMOTIONS TOGETHER
MAKE YOUR HOME A PLACE OF EMOTIONAL INTERSECTION

40

FOLDING WINDOW

Reference size: **2.5m²** | Aluminum thickness: **1.2-2.0mm**
Can be made without bottom frame | Stop at any height

cost-effective and most popular



*Patented balancer
placed in the frame*



55

FOLDING WINDOW

Reference size: **7m²** | Aluminum thickness: **1.4-3.0mm**
Can be made without bottom frame | Stop at any height

Various colours

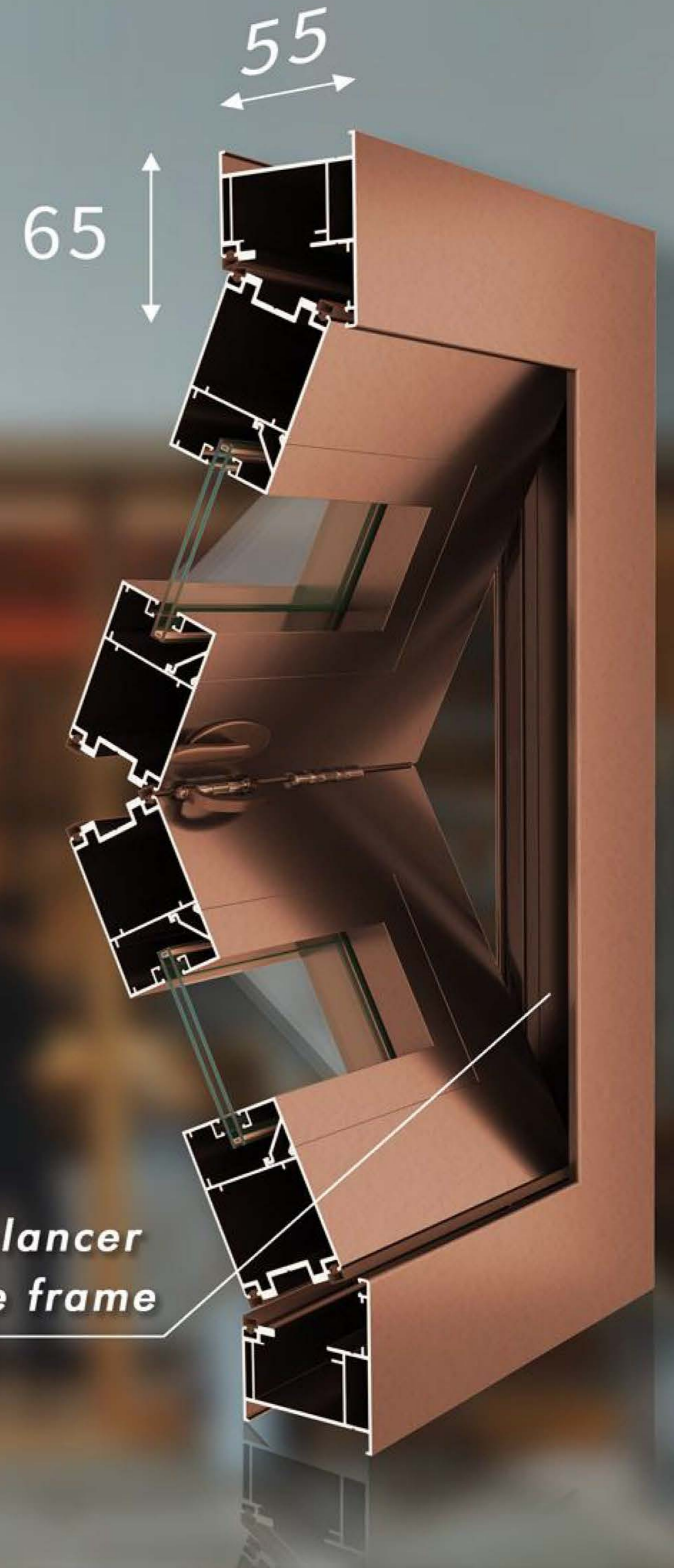

*Patented balancer
placed in the frame*

60

FOLDING WINDOW

Reference size: **10m²** | Aluminum thickness: **2.0-3.0mm**
Can be made without bottom frame | Stop at any height

Largest size in the folding series

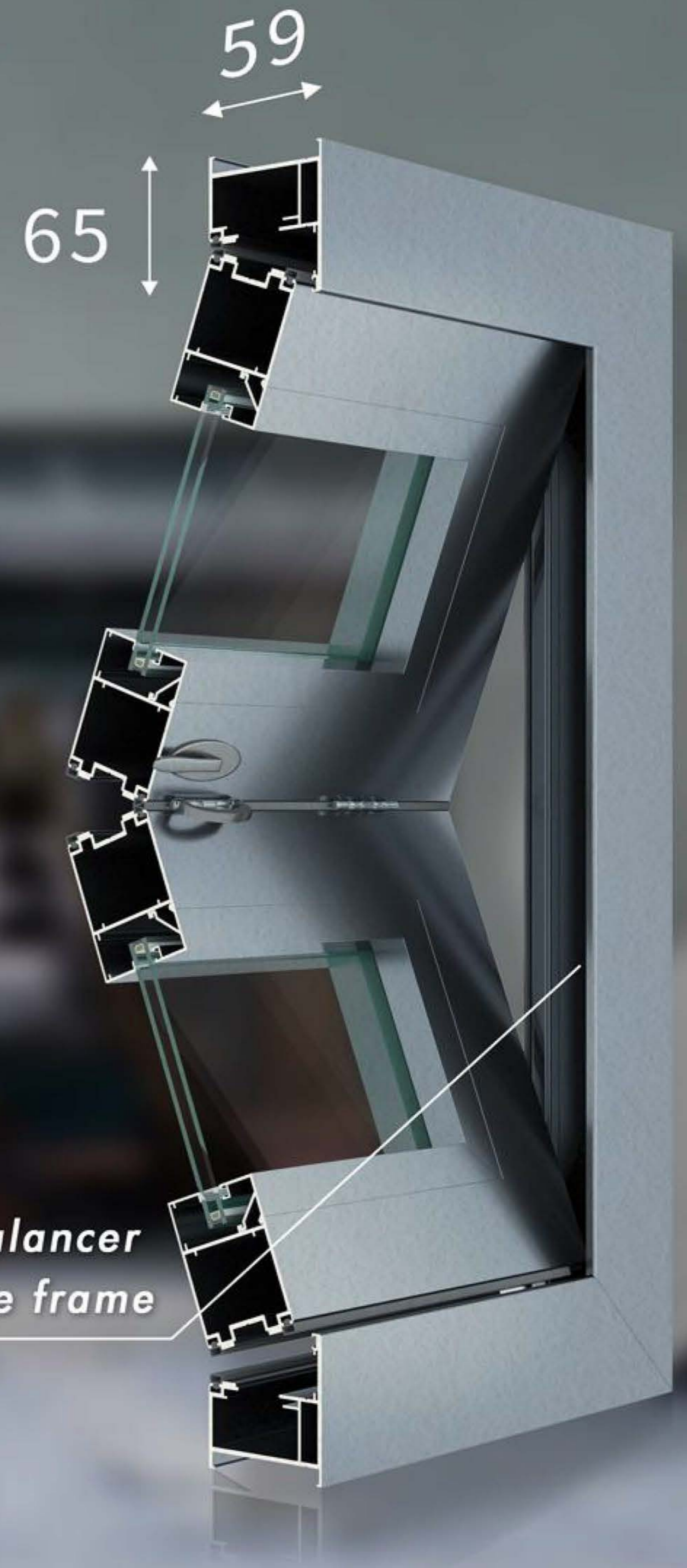

*Patented balancer
placed in the frame*

50

SINGLE-HUNG WINDOW

Reference size: **1.8m²** | Aluminum thickness: **1.2-1.4mm**
Can be made without bottom frame | Stop at any height

Moveable sash on the bottom or top / One sash with a tilting feature



*Patented balancer
placed in the frame*

70

SINGLE-HUNG WINDOW

Reference size: **7m²** | Aluminum thickness: **1.4-1.6mm**
Can be made without bottom frame | Stop at any height

Moveable sash on the bottom or top / One sash with a tilting feature

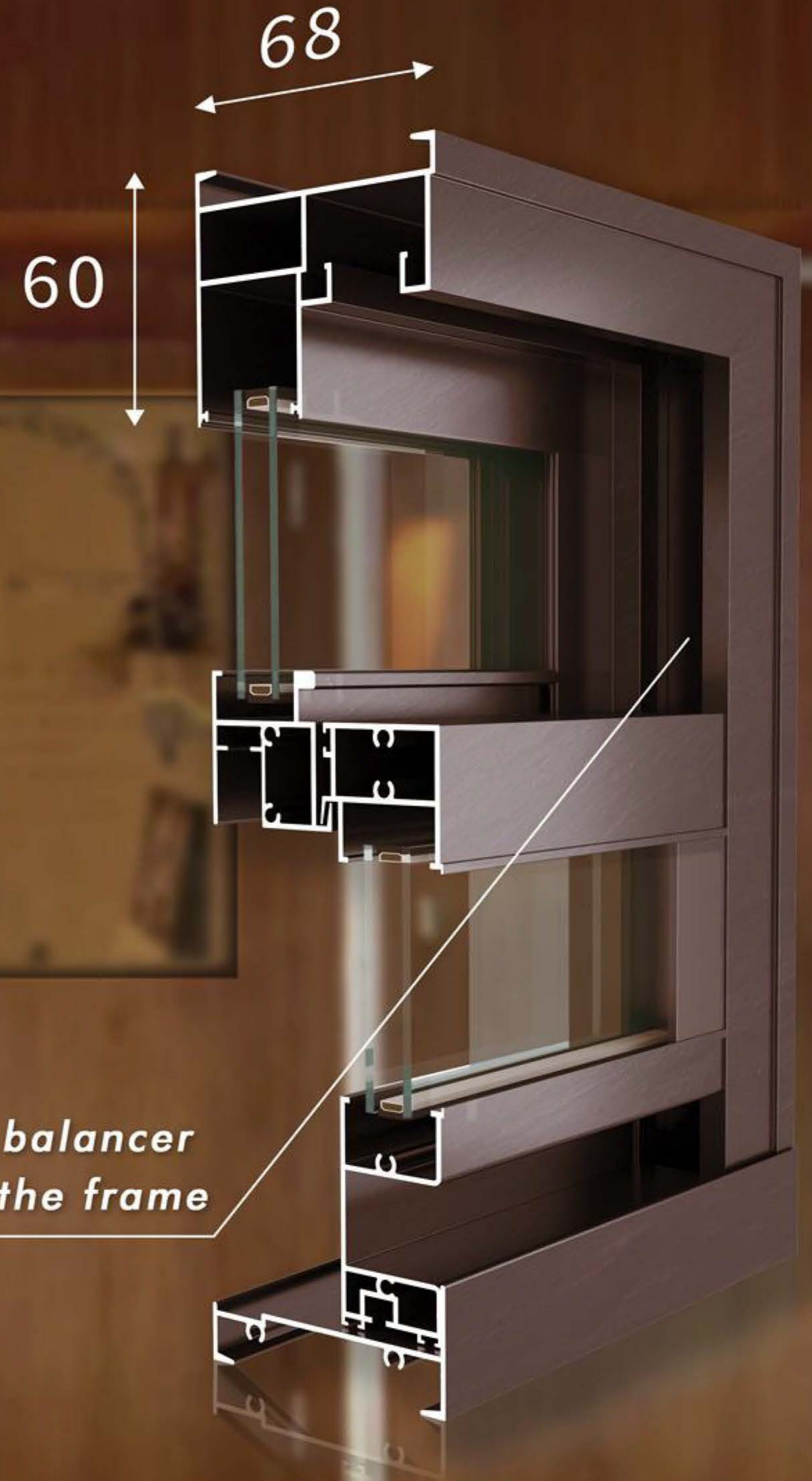

*Patented balancer
placed in the frame*

83

Thermal Break System Double-hung window

Reference size: **2.5m²** | Aluminum thickness: **1.5mm**
Can be made without bottom frame | Stop at any height

Two moveable sashes / Upper and lower sash with a tilting feature

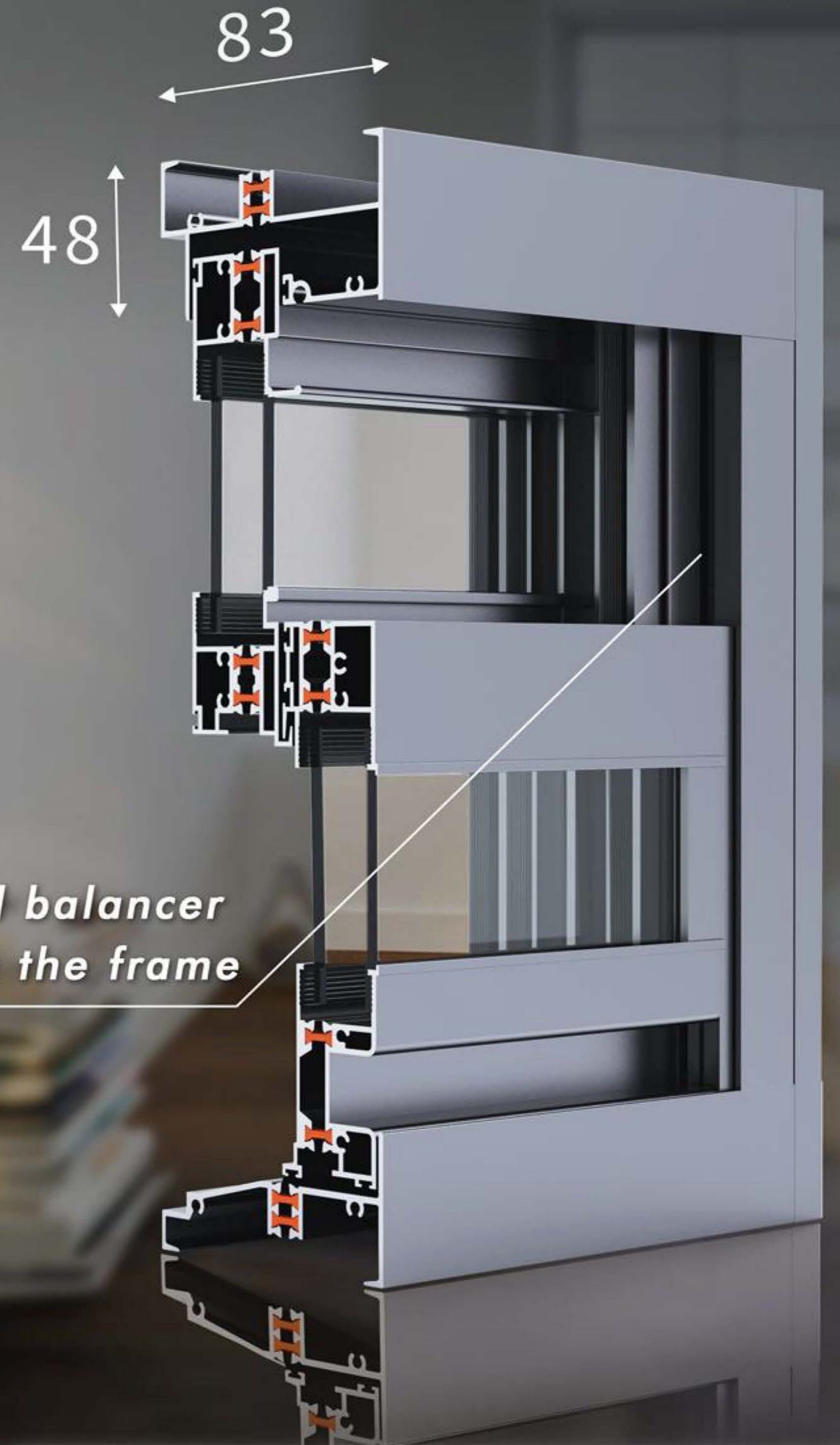

*Patented balancer
placed in the frame*

125

MINIMALIST INTELLIGENT SINGLE-HUNG WINDOW

Window and mesh integrated Width not more than **3m**
Three types of protection | Child lock | Extremely quiet running

Upgraded to an extremely narrow design



Adopt a more reliable mechanical lifting principle ✓

The hooked rabbit fasten securely

Extremely narrow handrail surface

Reinforced sealing effect of the bottom frame



158

MINIMALIST INTELLIGENT SINGLE-HUNG WINDOW

Window and mesh integrated | Width not more than **4.2m**
Three types of protection | Child lock | Extremely quiet running

An upgrade of the 168 series | Extremely narrow handrail surface

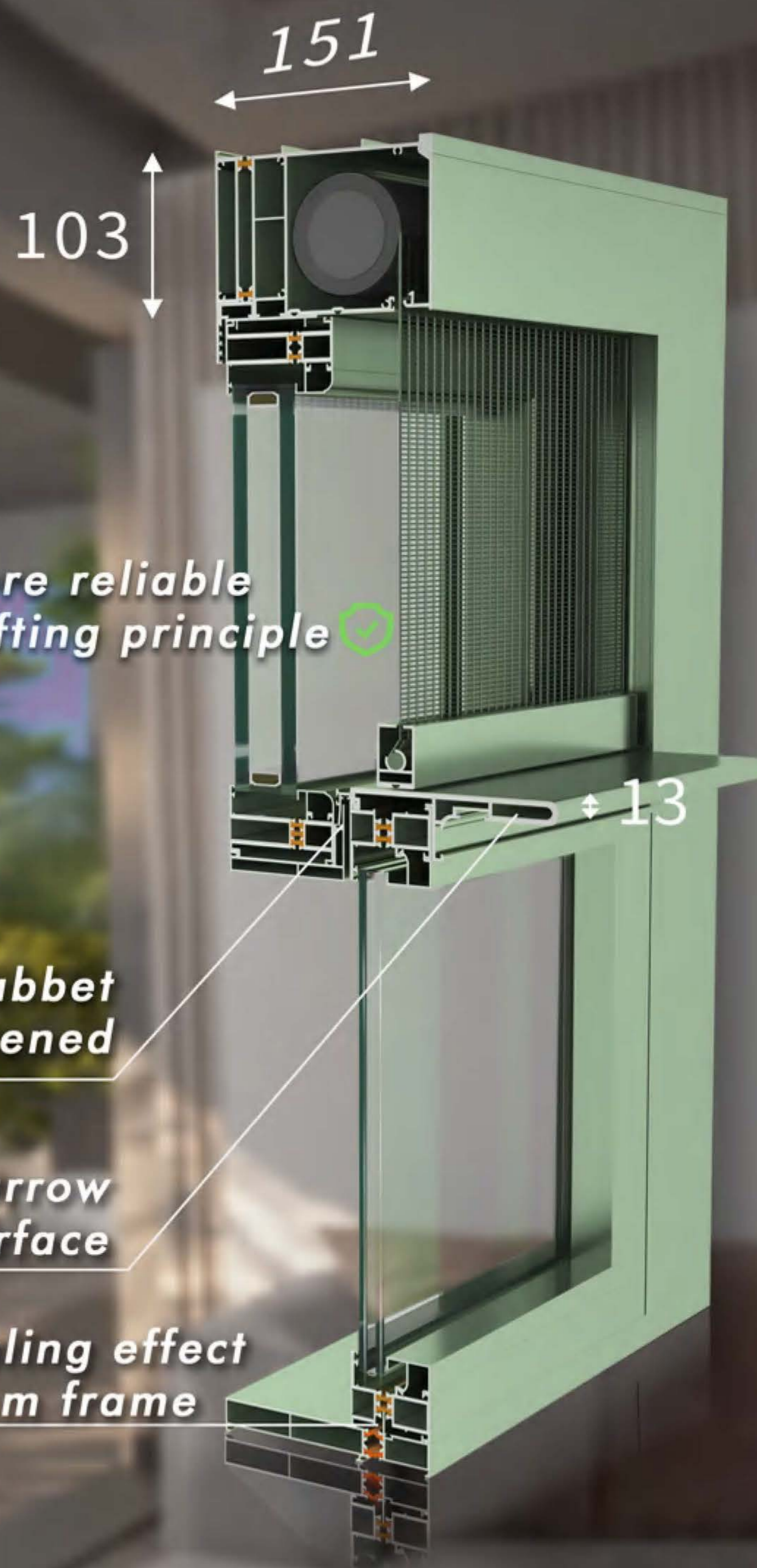

Adopt a more reliable mechanical lifting principle 

The hooked rabbet is securely fastened

Extremely narrow handrail surface

Reinforced sealing effect of the bottom frame



SYSTEM DOOR SERIES

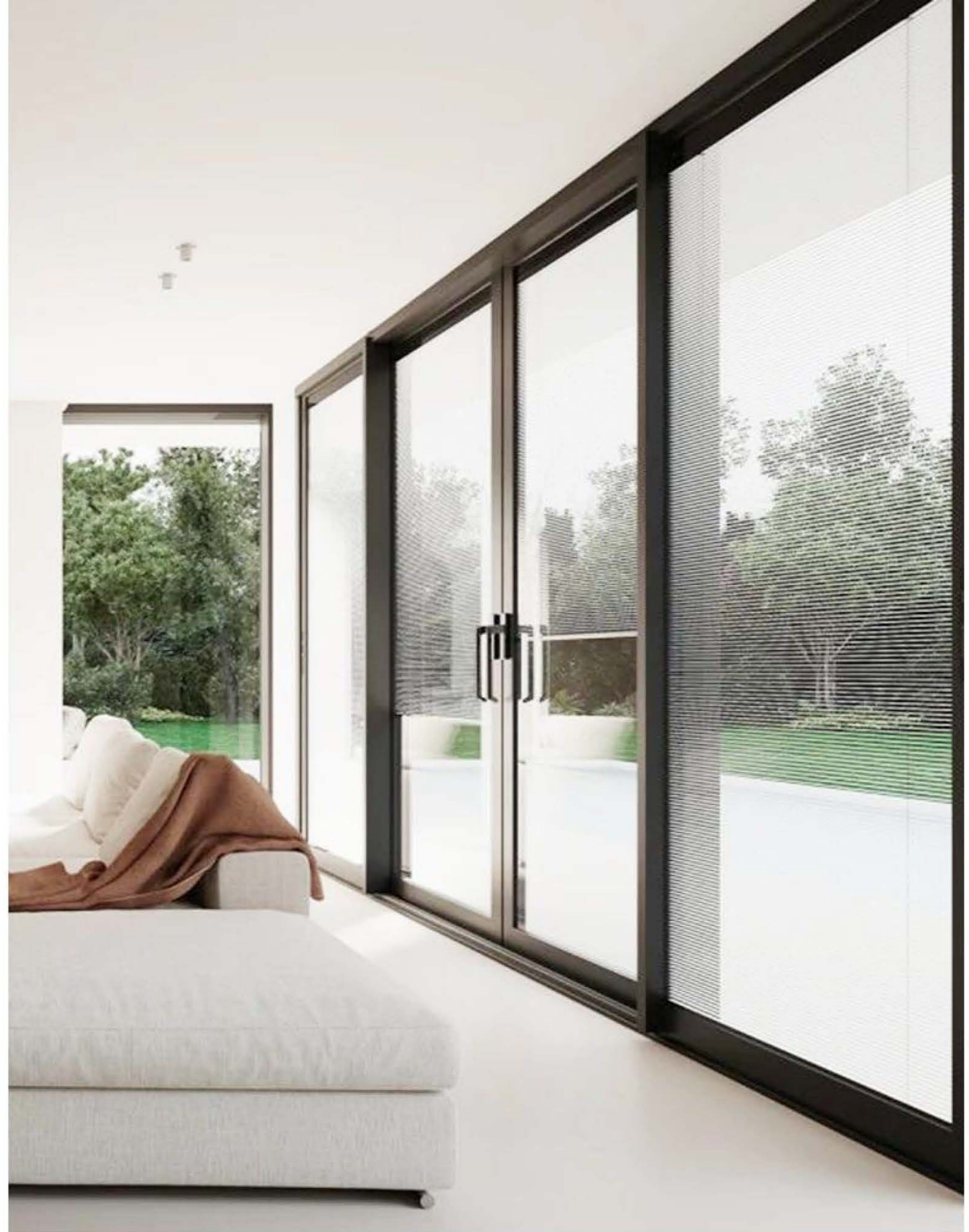

127

SLIDING DOOR



190

SLIDING DOOR



PRODUCT PARAMETER

Profile Wall Thickness

4.0mm

Frame Width

127/190mm

Opening Options

Push-and-pull

STANDARD CONFIGURATION

Profile Configuration

National Standard 6063-T5 Aluminum Alloy

Thermal Barrier

PA66 Nylon Thermal Break

Glass Configuration

5mm+20A+5mm Tempered Insulated Glass

Optional Glass Types

LOW-E / Coated / Smart / Tinted Glass

Hardware System

EMD System

Screen Mesh

Diamond Mesh / Folding Gauze

Shading System

Glass Blinds / Windproof Shutter

Lower Track Configuration

High Track With Water Barrier / Low Track



POSSESSING AN EXTRAORDINARY AND INNOVATIVE SENSE
OF SOPHISTICATION
IMPLEMENTING INNOVATION FROM TECHNOLOGY AND AESTHETICS
EXTENDED APPLICABLE SCENARIOS
PURSUING THE "SEAMLESS LANDING" OF SPATIAL PARTITION
EXPERIENCE THE LIGHTNESS AND AGILITY ON PAPER

E-127/190

SLIDING DOOR



TY150

SLIDING DOOR



PRODUCT PARAMETER

Profile Wall Thickness

5.0mm

Frame Width

150mm

Opening Options

Push-And-Pull

STANDARD CONFIGURATION

Profile Configuration

National Standard 6063-T5 Aluminum Alloy

Thermal Barrier

PA66 Nylon Thermal Break

Glass Configuration

5mm+27A+5mm Tempered Insulated Glass

Optional Glass Types

LOW-E / Coated / Smart / Tinted Glass

Hardware System

EMD System

Screen Mesh

Diamond Mesh / Folding Gauze

Lower Track Configuration

High Track With Water Barrier / Low Track

Shading System

Glass Blinds / Windproof Shutter

TY150

SLIDING DOOR

- Barrier-free passage, safer
- Linear embedded track design
- Watertight, airtight performance is outstanding
- Better sound insulation
- Track optional marble, tile, rock board, Wooden floor, with the ground integrated, It further exudes the grandeur of a luxury mansion.

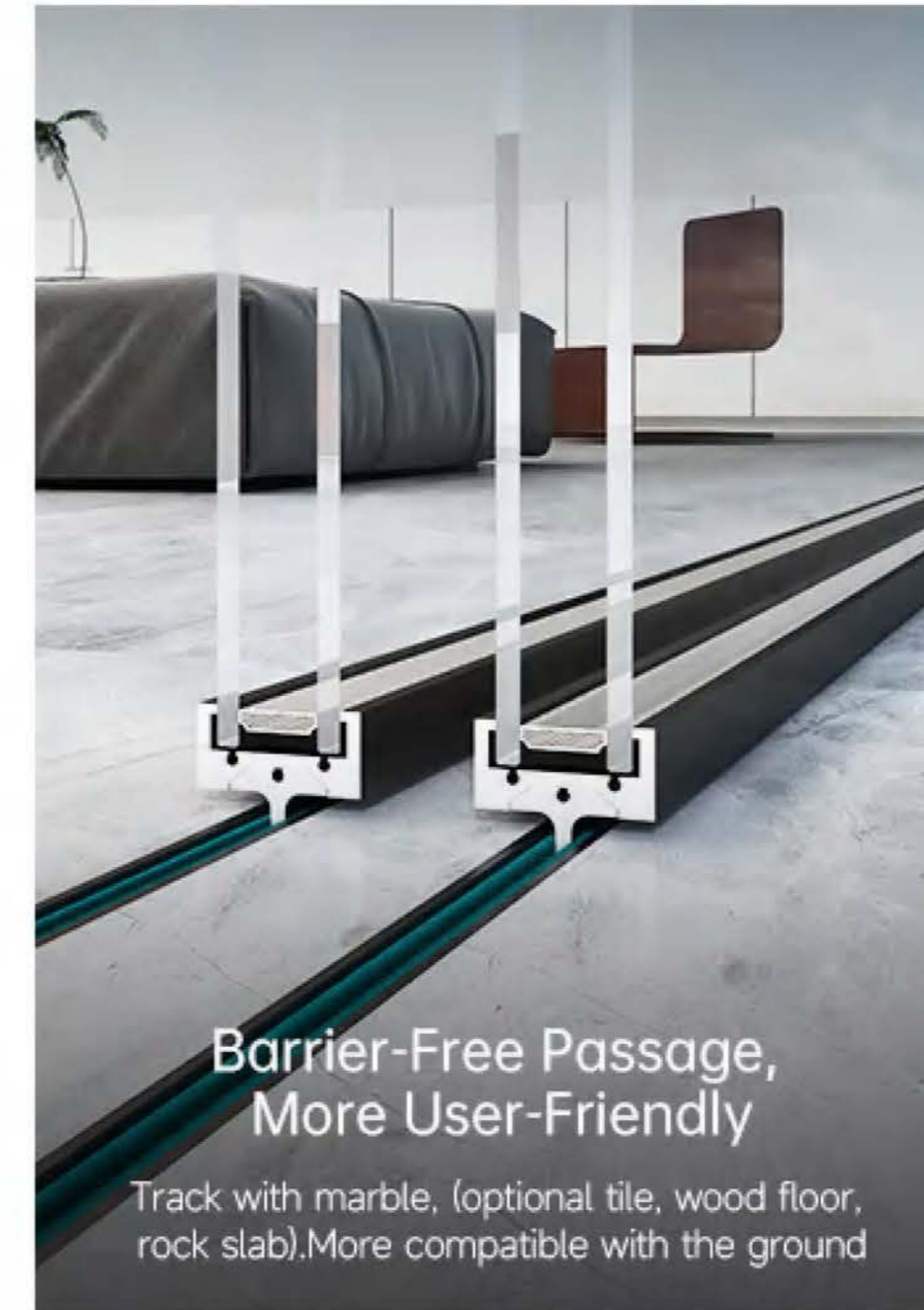
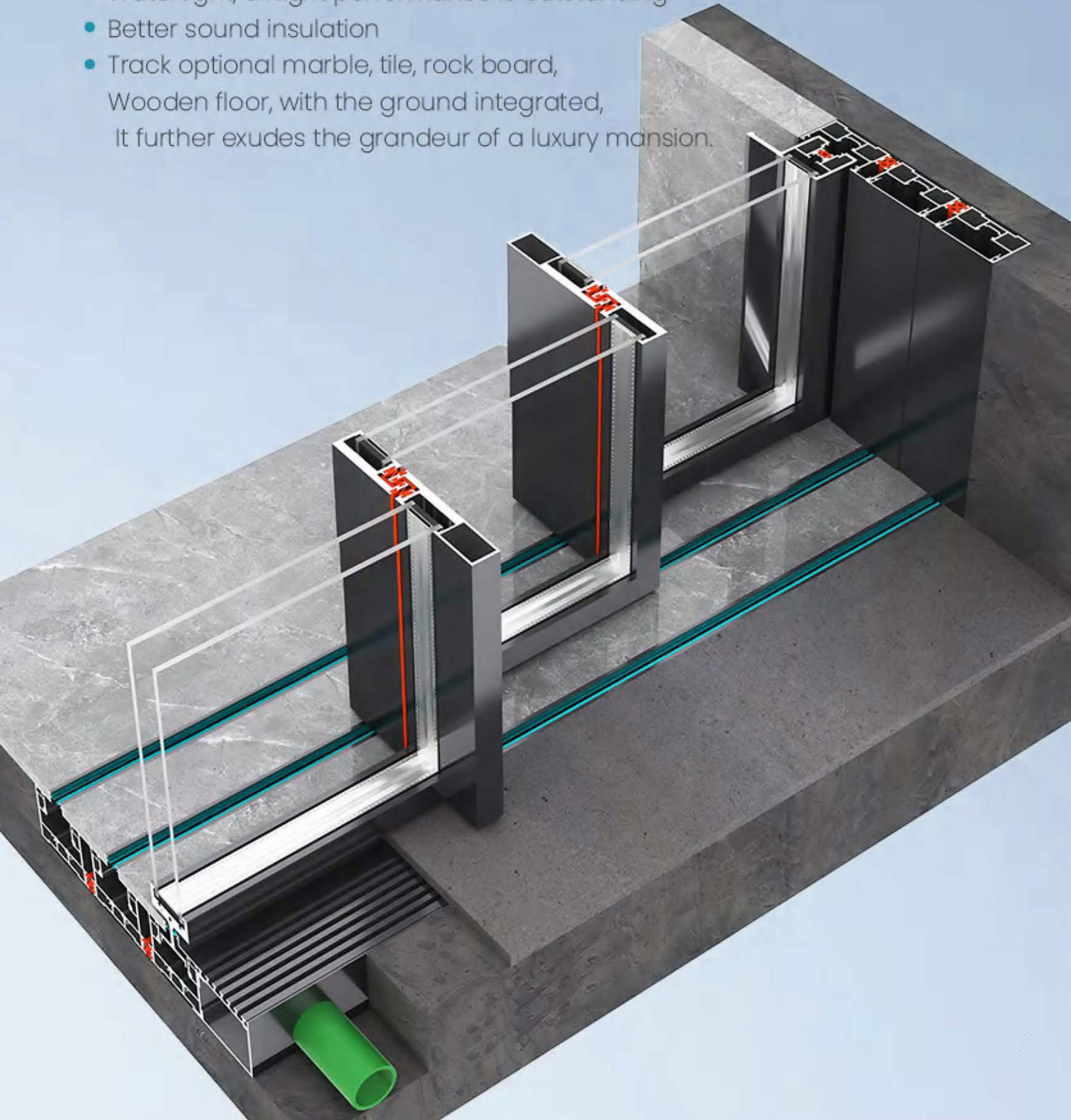

Barrier-Free Passage, More User-Friendly

Track with marble, (optional tile, wood floor, rock slab). More compatible with the ground

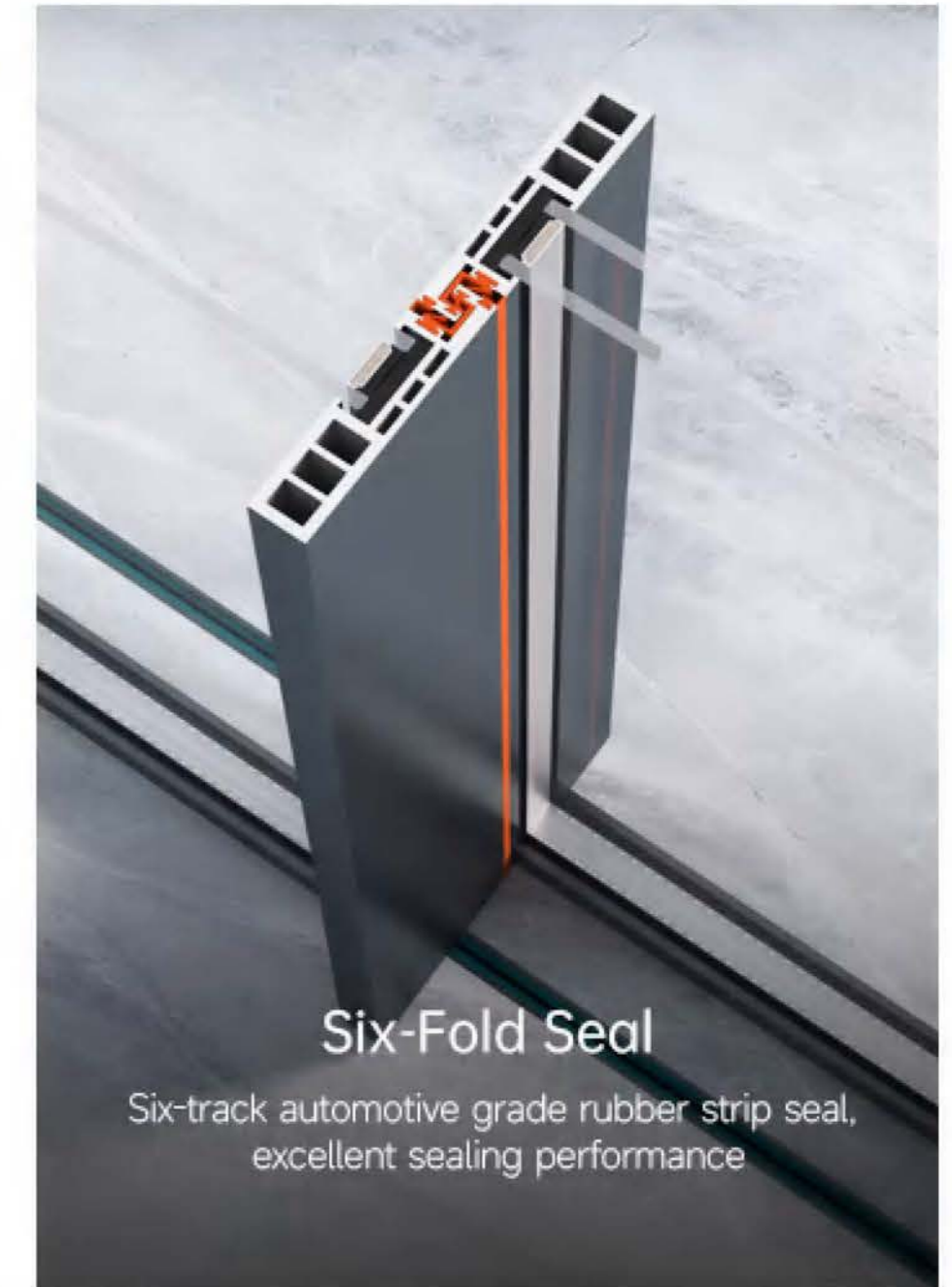

Six-Fold Seal

Six-track automotive grade rubber strip seal, excellent sealing performance



More Stable, More Secure

Achieve the middle fixed, both sliding / Both sides fixed, the middle sliding functions

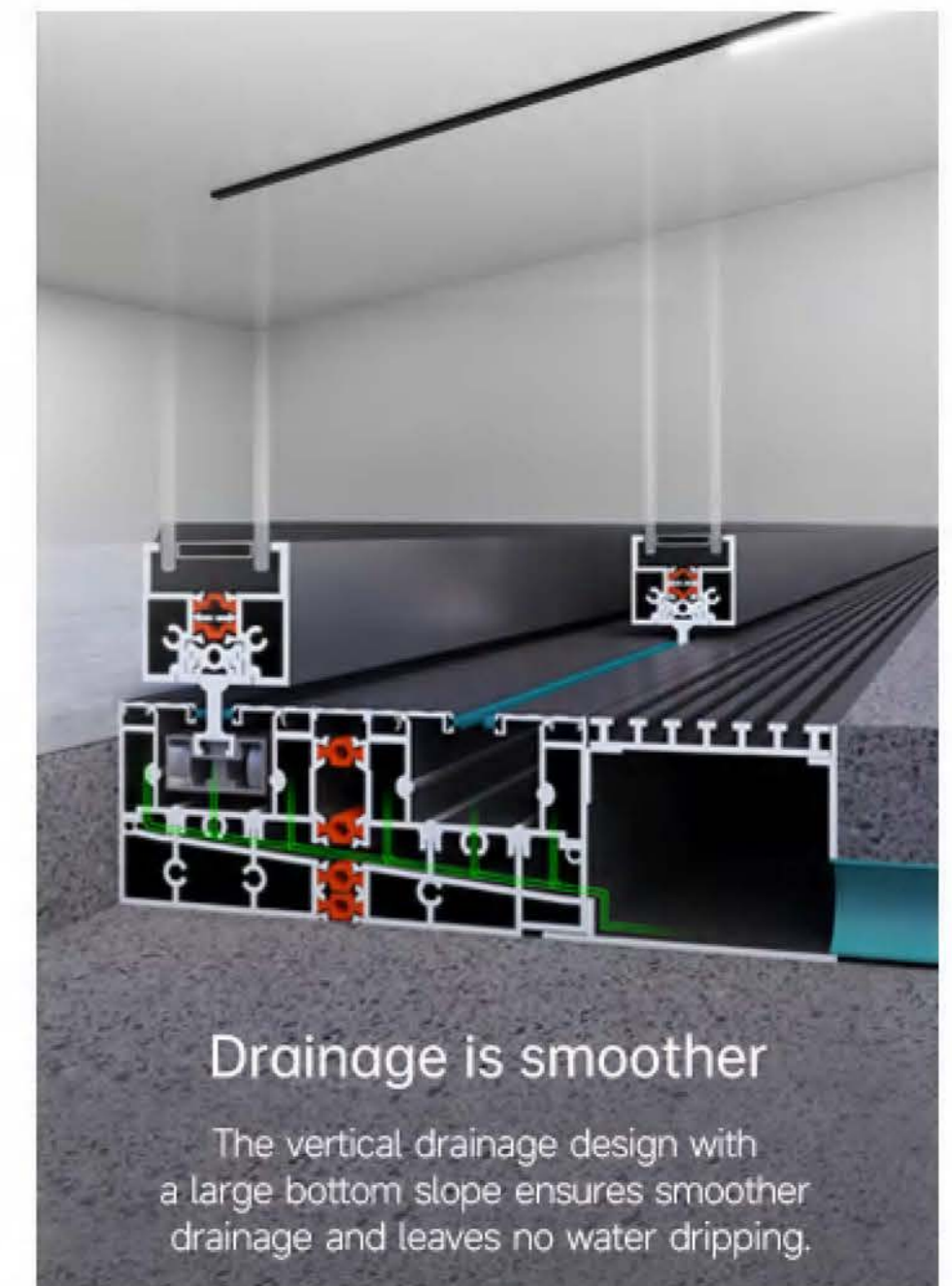

Drainage is smoother

The vertical drainage design with a large bottom slope ensures smoother drainage and leaves no water dripping.



SPECIAL DESIGN STYLE TO CREATE DIFFERENT HOME ATMOSPHERES AND DISCOVER UNEXPECTED BEAUTY. BOTH FUNCTION AND BEAUTY ARE EMPHASIZED, WITH NARROWER BORDERS AND A MORE MINIMALIST AND DELICATE TOUCH

TY150

SLIDING DOOR





ARCH DOORS



65

HEAVY TYPE FOLDING DOOR

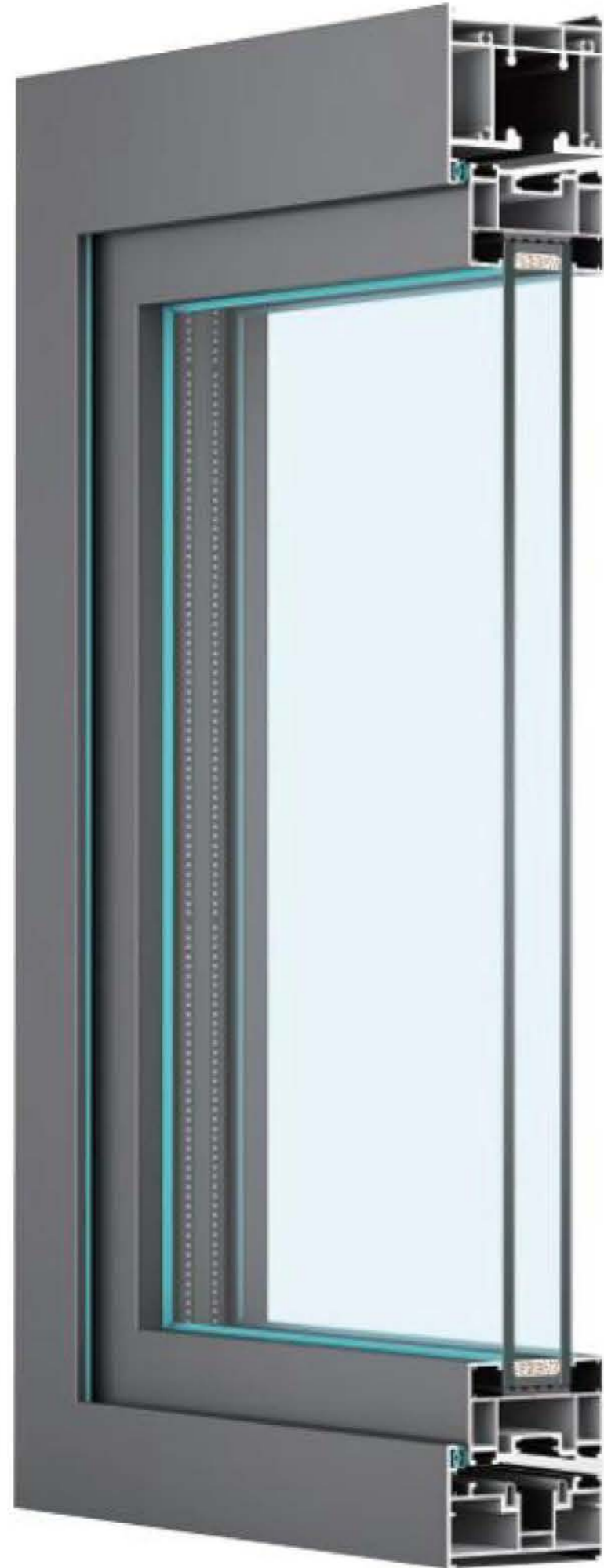

PRODUCT PARAMETER

Profile Wall Thickness

2.0 mm

Frame Width

65mm

Opening Options

Push-And-Pull

STANDARD CONFIGURATION

Profile Configuration

National Standard 6063-T5 Aluminum Alloy

Thermal Barrier

PA66 Nylon Thermal Break

Glass Configuration

5mm+20A+5mm Tempered Insulated Glass

Optional Glass Types

LOW-E / Coated / Smart / Tinted Glass

Hardware System

KERSENBERG

HARDWARE CONFIGURATION



• Swing Lock (Optional)

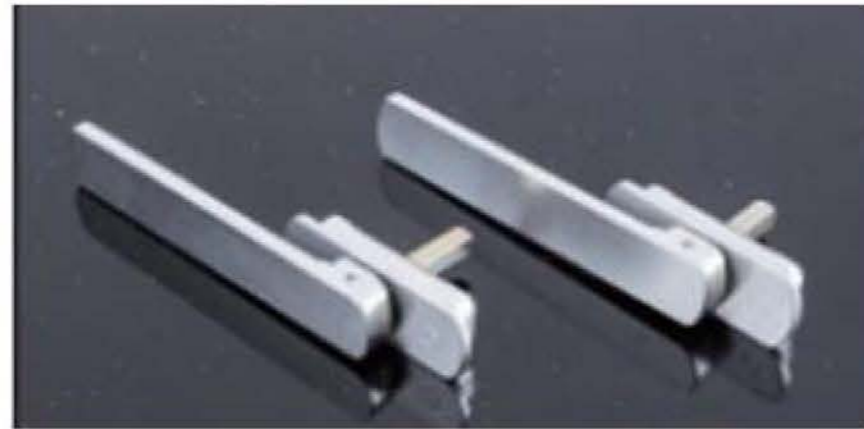

• Sword-Type Lock



• Lock Cylinder (Optional)



• Optional Lock Body (Optional)

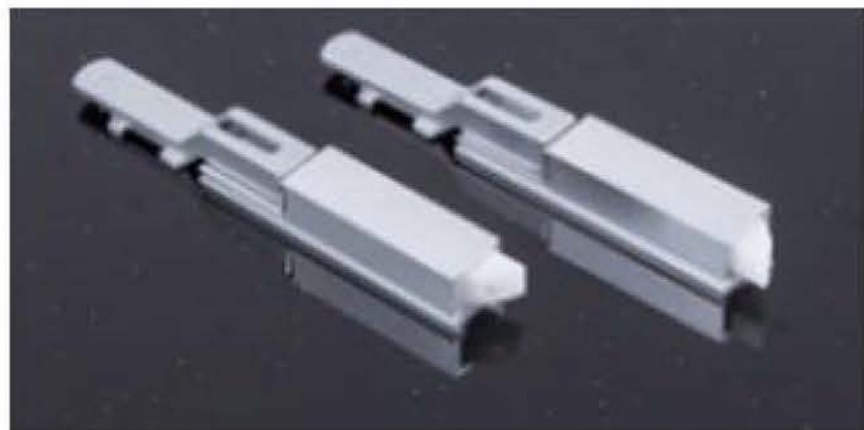

• Automatic Bolt



• Handle Hinge



• Single Hinge



• Top Guide Wheel



• Bottom Wheel



• Hanger Wheel



BUILDING A REASONABLE SENSE OF ORDER FOR MINIMALISM
WITH SIMPLE YET EXTRAORDINARY DETAILS
CREATING EVERY BIT OF BEAUTY IN LIFE

68KSBG

NON-THERMAL BREAK, ANTI-PINCH HEAVY-DUTY FOLDING DOOR

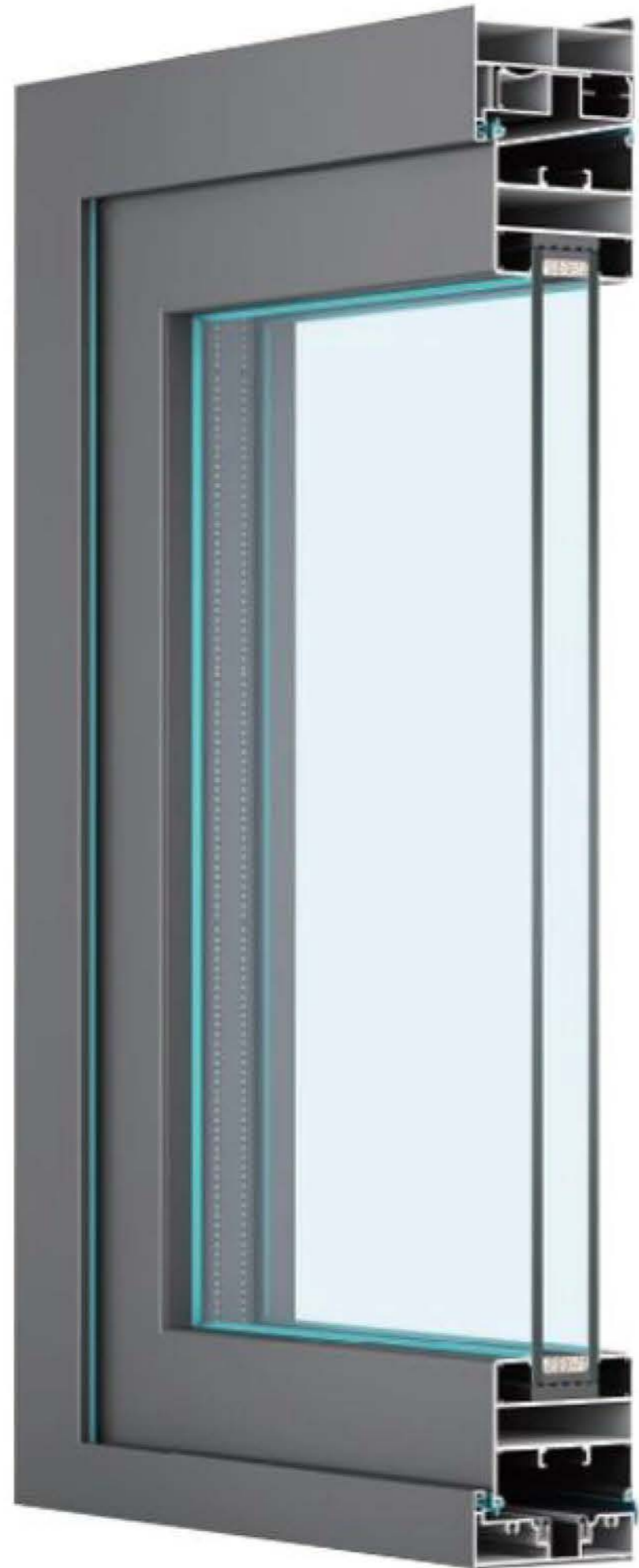

PRODUCT PARAMETER

Profile Wall Thickness

2.0 mm

Frame Width

68mm

Single Fan Size Limit

Maximum Width: 850mm
Maximum Height: 3600mm

Opening Options

Push-And-Pull

STANDARD CONFIGURATION

Profile Configuration

National Standard 6063-T5 Aluminum Alloy

Thermal Barrier

PA66 Nylon Thermal Break

Glass Configuration

5mm+20A+5mm Tempered Insulated Glass

Optional Glass Types

LOW-E / Coated / Smart / Tinted Glass

Hardware System

KERSSENBERG

HARDWARE CONFIGURATION



• Single-Side Handle Lock



• Handle



• Lock Body



• Auto Top & Bottom Bolts



• 3+1 Bottom Wheels
Top Wheel



• Hinge



• Double-Side Handle Lock
(Optional)



• Double-Side Handle Lock
(Optional)



• Lock Body with Core
(Optional)



• Dual Hanger Wheels
(Optional)



• Hanger Wheels (Optional)



• 2+0, 3+1 Steel Wheels
(Optional)

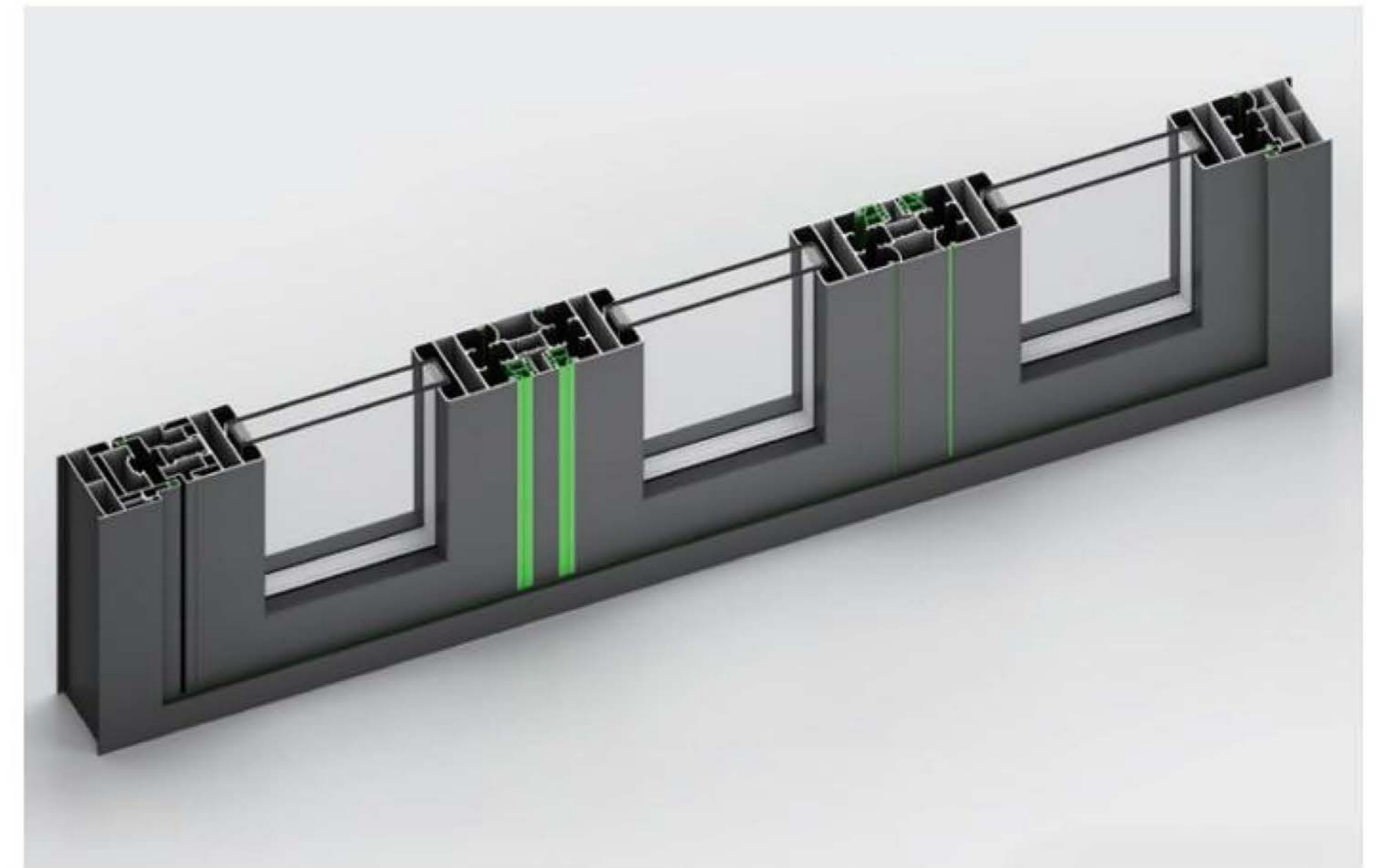

PINCH-FREE DESIGN, SPACIOUS INTERIOR

Meticulous details showcase quality and care. Superior stain resistance ensures effortless maintenance.



80KSBG

NON-THERMAL BREAK, ANTI-PINCH HEAVY-DUTY FOLDING DOOR

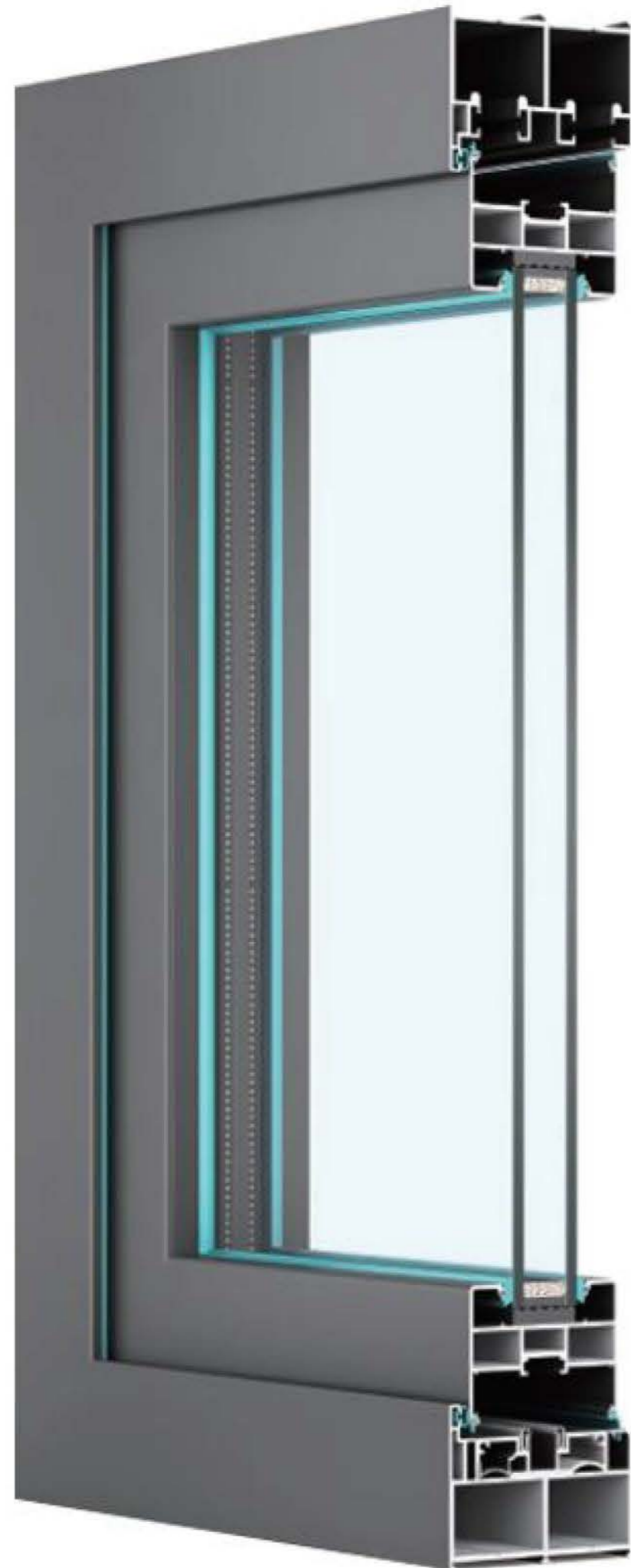

PRODUCT PARAMETER

Profile Wall Thickness

2.0 mm

Frame Width

80mm

Single Fan Size Limit

Maximum Width: 900mm

Maximum Height: 4800mm

Opening Options

Push-And-Pull

STANDARD CONFIGURATION

Profile Configuration

National Standard 6063-T5 Aluminum Alloy

Thermal Barrier

PA66 Nylon Thermal Break

Glass Configuration

5mm+27A+5mm Tempered Insulated Glass

Optional Glass Types

LOW-E / Coated / Smart / Tinted Glass

Hardware System

KERSSENBERG

Screen Mesh

0.45 High-Definition Screen / Folding Screen Mesh

HARDWARE CONFIGURATION



• Single-Side Handle Lock



• Handle



• Lock Body



• 3+1 Bottom Wheels
Top Wheel



• Hinge



• 2+0 Hanger Wheel
System



• Double-Side Handle Lock
(Optional)



• Double-Side Handle Lock
(Optional)



• Lock Body with Core
(Optional)



• Auto Top & Bottom Bolts



• 3+1 Hanger Wheel
System



• 2+0, 3+1 Steel Wheels
(Optional)





120 OUTDOOR FLAT DOOR

NOT LIMITED TO LIMITED SPACE, WHEN A SENSE OF STRUCTURE INTERVENES
LIGHT AND SHADOW ADD DEPTH TO THE SPACE





120

ALUMINUM SHUTTER DOORS



OUTDOOR SPRING DOOR

THE INTERWEAVING OF NATURAL AND MODERN BEAUTY,
BLOOMING A PROFOUND CHARM IN SPACE,
THE DELICATE TEXTURE ON THE SURFACE ENHANCES THE
BEAUTY OF NATURE,
SHOWCASED TO THE FULLEST EXTENT,
ADDING A TOUCH OF SPACE,
THE UNIQUE CHARM THAT ONE YEARNS FOR.

PT DOOR

SWING OR SLIDE – IT ADAPTS TO YOUR NEEDS!
EXPERIENCE VERSATILITY WITH DUAL OPENING OPTIONS,
SWING OR SLIDE, DESIGNED TO TRANSFORM
YOUR USAGE EXPERIENCE.



DOUBLE-TRACK



TRIPLE TRACK



TRIPLE SYNCHRONIZATION



TRIPLE SYNCHRONIZATION



HINGE





65*33 PT DOOR

DUAL-TRACK AND TRIPLE-TRACK WITH DIAMOND MESH SCREENS

PRODUCT PARAMETER

Profile Wall Thickness
1.6mm

Hook Profile Width
65mm



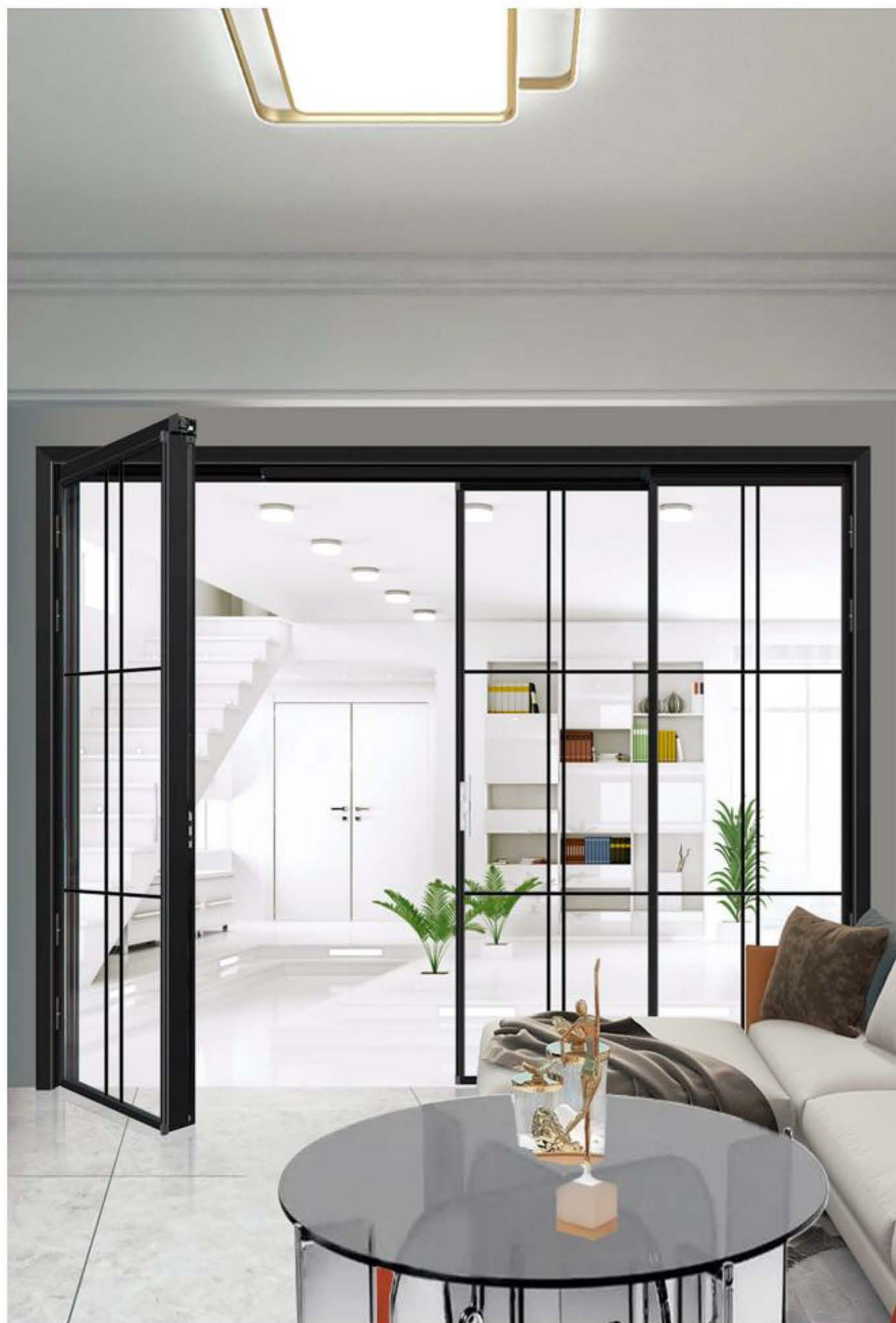

33*23 PT DOOR

DUAL-TRACK AND TRIPLE-TRACK

PRODUCT PARAMETER

Profile Wall Thickness

2.0mm

Hook Profile Width

23mm





16 PT DOOR

SINGLE-GLASS PT DOOR

PRODUCT PARAMETER

Profile Wall Thickness
1.2mm

Hook Profile Width
16mm





INTERIOR SLIDING DOOR

PREMIUM HANGING SLIDING DOOR, TWO TRACKS, TWO PANELS/TWO TRACKS, FOUR PANELS
THREE TRACKS, TRIPLE SYNCHRONIZATION

PRODUCT PARAMETER

Profile Wall Thickness

3.0mm

Frame Width

100/152 mm

Opening Options

Two-Rail Two-Panel Sliding / Two-Rail Four-Panel Sliding / Three-Rail Triple-Linked Sliding

STANDARD CONFIGURATION

Profile Configuration

National Standard 6063-T5 Ultra-High Precision
Aluminum Alloy

Glass Configuration

8mm Tempered Insulated Glass

Hardware System

EMD Hardware

Thermal Barrier

PA66 Nylon Thermal Break

Optional Glass Types

LOW-E / Coated / Smart / Tinted Glass



INTERIOR SLIDING DOOR

DESIGN IS SEEN IN THE WHOLE, FULLY HIDDEN IN THE DETAILS,
EXPLORING THE DETAILS WITH CARE,
AND TOUCHING THE INHERENT QUALITY



INDOOR · FLAT DOORS

FREE MATCHING, FANTASY COMBINATION





INTERIOR PIVOT DOORS

SPECIAL DESIGN STYLE TO CREATE DIFFERENT HOME
ATMOSPHERES AND DISCOVER,
UNEXPECTED BEAUTY, BOTH FUNCTION AND BEAUTY ARE
EMPHASIZED, WITH NARROWER BORDERS AND A MORE
MINIMALIST AND DELICATE TOUCH



INTERIOR FRENCH DOOR

SPECIAL DESIGN STYLE TO CREATE DIFFERENT HOME
ATMOSPHERES AND DISCOVER UNEXPECTED
BEAUTY. BOTH FUNCTION AND BEAUTY ARE
EMPHASIZED, WITH NARROWER BORDERS AND A MORE
MINIMALIST AND DELICATE TOUCH

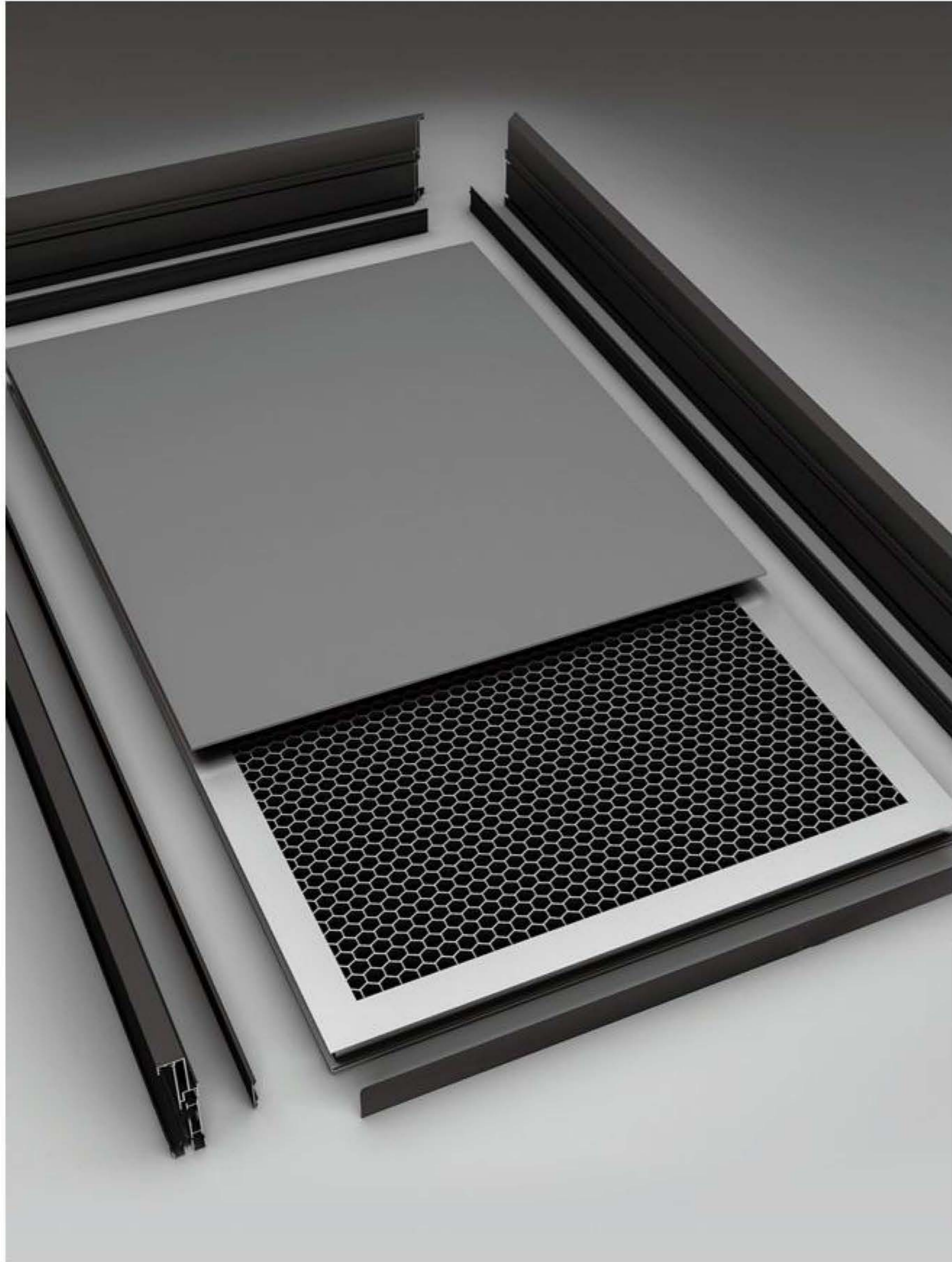

ALUMINIUM WOOD DOOR

DOORWALL CABINET FULL CASE LANDING
SERVICE PROVIDER



Fireproof



Insect Prevention



Eco-Friendly



Fashionable



Wearproof



YD-M-001



YD-M-002



YD-M-003



YD-M-004



YD-M-005



YD-M-006



YD-M-013



YD-M-014



YD-M-015



YD-M-007



YD-M-008



YD-M-009



YD-M-010



YD-M-011



YD-M-012



YD-M-016



YD-M-017



YD-M-018



ACCESSORIES



Door Lock

Attachment



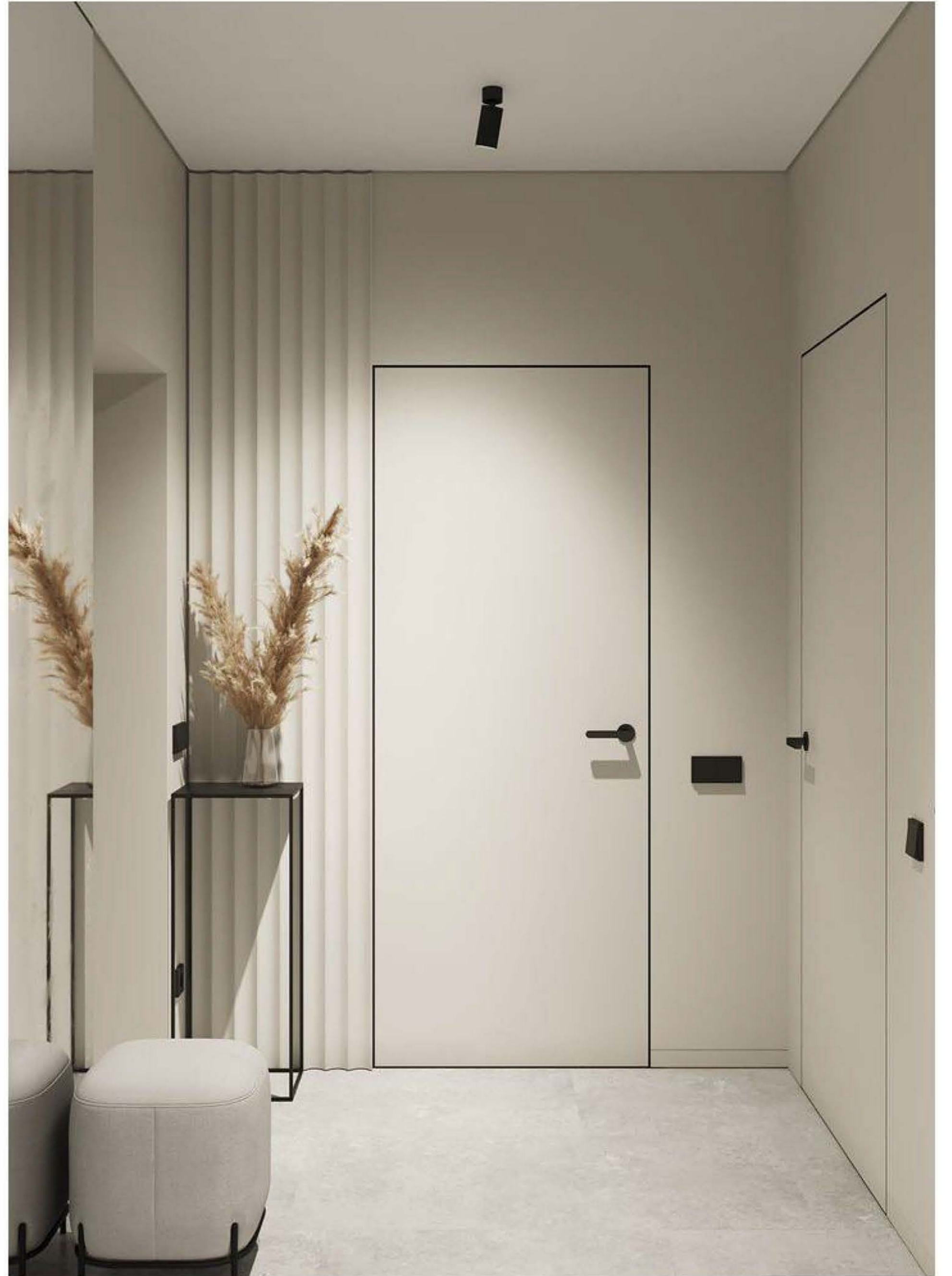

SYSTEM SUNROOM SERIES

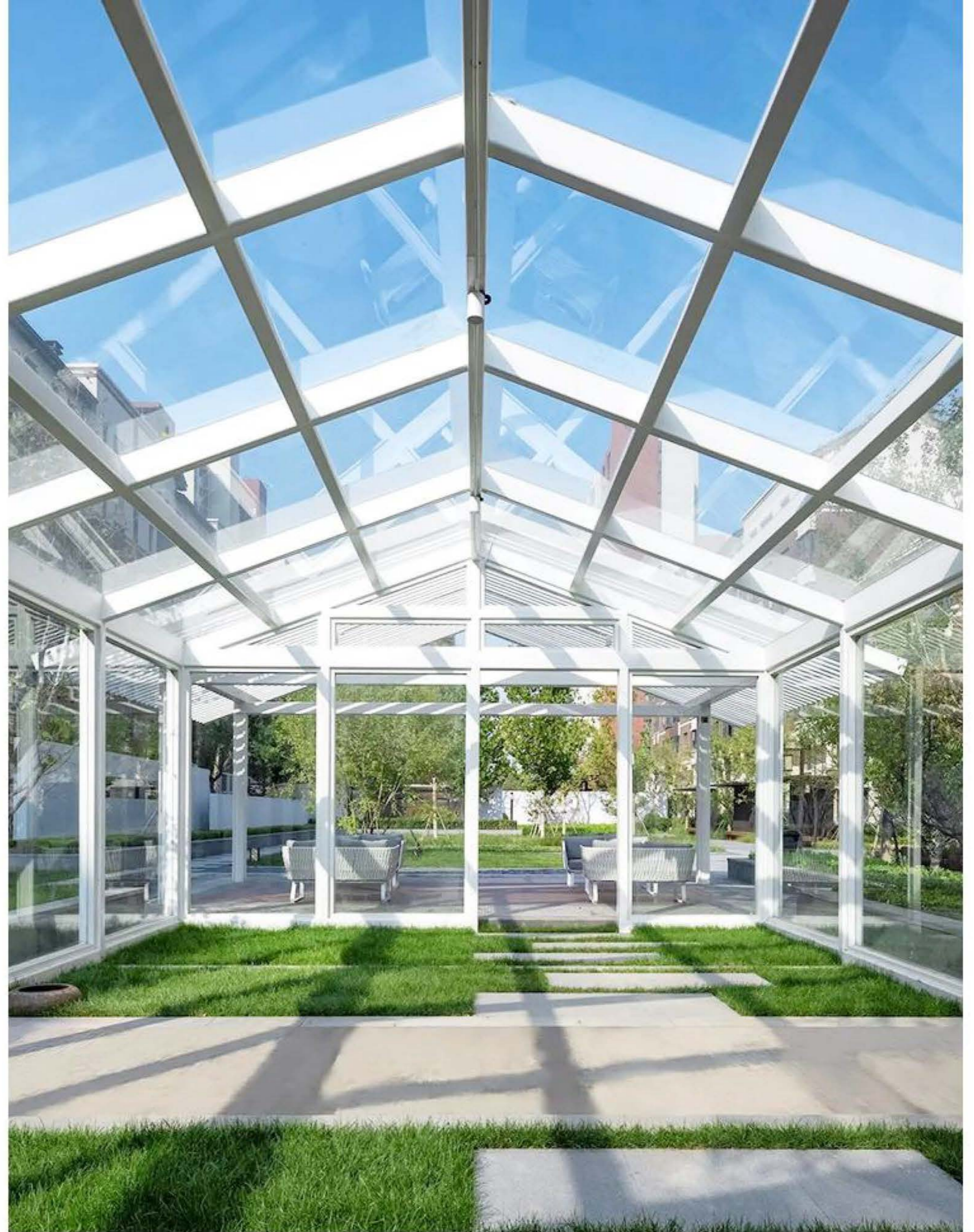

SUNROOM

A sunroom is an enclosed living space that is designed to let innatural light while protecting occupants from the elements.



PRODUCT PARAMETER

Profile Wall Thickness

3.0 mm

Structure Width

120mm

Glass Option

5mm+1.14PVB+5mm Tempered Laminated Glass / Other Glass Options

Profile Configuration

National Standard 6063-T5 Aluminum Alloy

OPTIONAL APPEARANCE STYLES

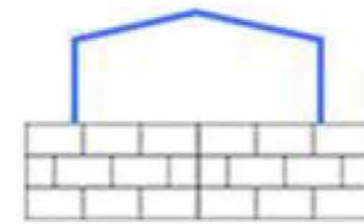

High Gable

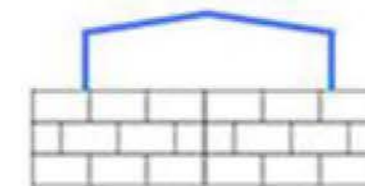

Low Gable

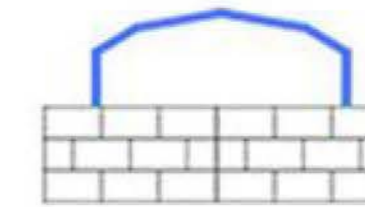

High Multi-Arch

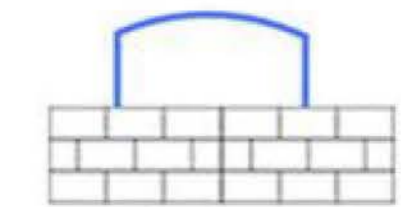

High Canopy

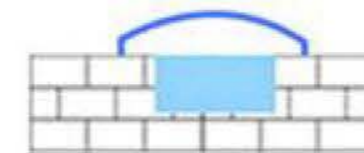

Low Canopy

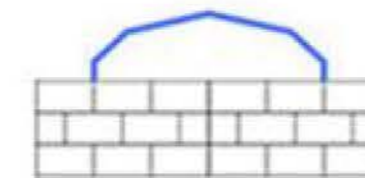

Low Multi-Arch

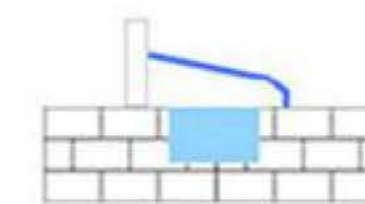

Low Single-Side
Multi-Slope

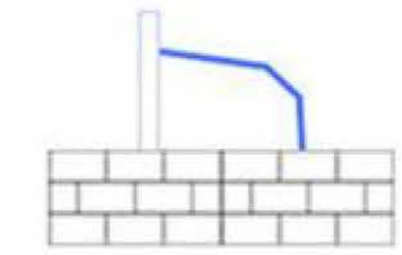

High Single-Side
Multi-Slope

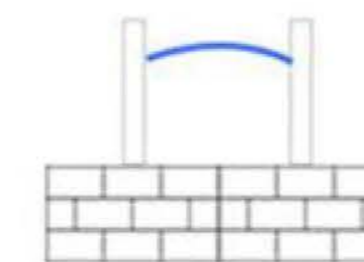

Curved Canopy

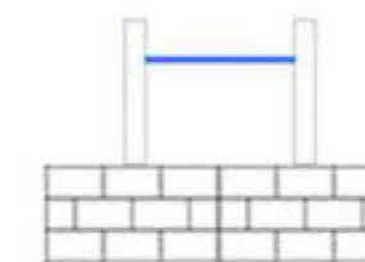

Flat Canopy

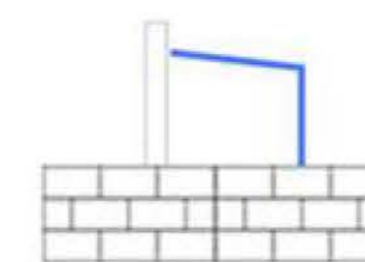

High Single-Side
Gable

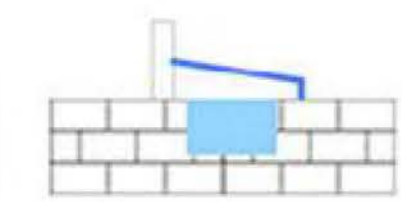

Low Single-Side
Gable



FLAT-ROOFED SUNROOM

BASK IN THE SUNLIGHT, EMBRACE LIFE —
YOUR EXCLUSIVE FLAT ROOF SUNROOM
TIRED OF THE CITY'S HUSTLE AND BUSTLE,
YEARNING FOR A TRANQUIL SPACE OF YOUR OWN?
EMD FLAT ROOF SUNROOM CREATES THE SUNLIT
RETREAT OF YOUR DREAMS.



GABLE-ROOFED SUNROOM

GABLE ROOF SUNROOM, ALLOWING YOU TO ENJOY SUNSHINE,
NATURE, AND A COMFORTABLE LIFE WITHOUT LEAVING YOUR HOME.



ARCHED ROOF SUNROOM

THE ARCHED-TOP SUNROOM, WITH ITS GRACEFUL AND FLOWING CURVES, OUTLINES THE SUNLIT SPACE OF YOUR DREAMS.



PORTABLE SUNROOM

EXPERIENCE A NEW REALM OF LIVING WITH OUR STATE-OF-THE-ART MOVABLE SUNROOM! FREELY EXPANDABLE, IT ALLOWS YOU TO CONTROL YOUR SPACE AS YOU DESIRE!



1

2

3



4



5



6



7



8



9

SKYLIGHT

Sliding skylights, lifting skylights, manual skylights,
custom-made according to your needs.





SUNLIGHT DANCING ACROSS YOUR FLOORS, NO MATTER WHERE YOU ARE IN THE WORLD. OUR SKYLIGHTS ARE DESIGNED TO MAXIMIZE NATURAL LIGHT, CREATING A WARM AND INVITING ATMOSPHERE IN ANY CLIMATE.

BRING THE WORLD CLOSER, ONE SKYLIGHT AT A TIME
TIRED OF THE SAME OLD VIEW? OPEN YOUR HOME TO THE WORLD
WITH OUR PREMIUM SKYLIGHTS, CRAFTED TO TRANSCEND
BORDERS AND ELEVATE YOUR LIVING SPACE.



ALUMINIUM ALLOY SHUTTER PERGOLA





WIDE OPENING ANGLE

The blade opening angle reaches 90°, allowing adjustment of shading and airflow as needed.

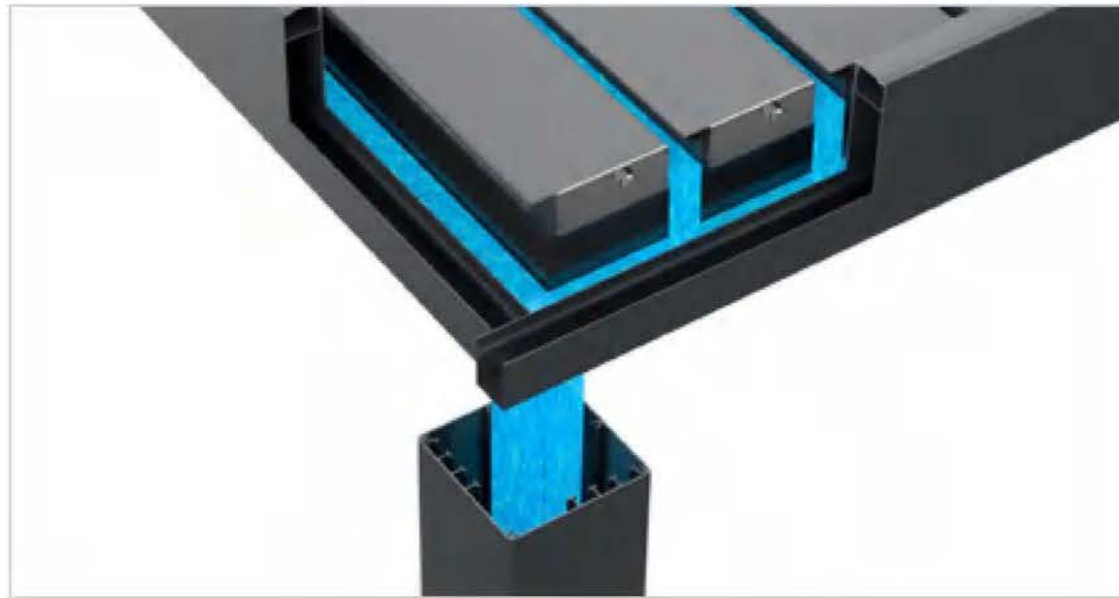

DUAL DRAINAGE SYSTEM

This system is designed to effectively prevent rainwater splashing from the surrounding areas. The top surface can withstand rainfall with an intensity of 40-50 milliliters per second per square meter, lasting for up to 2 minutes.

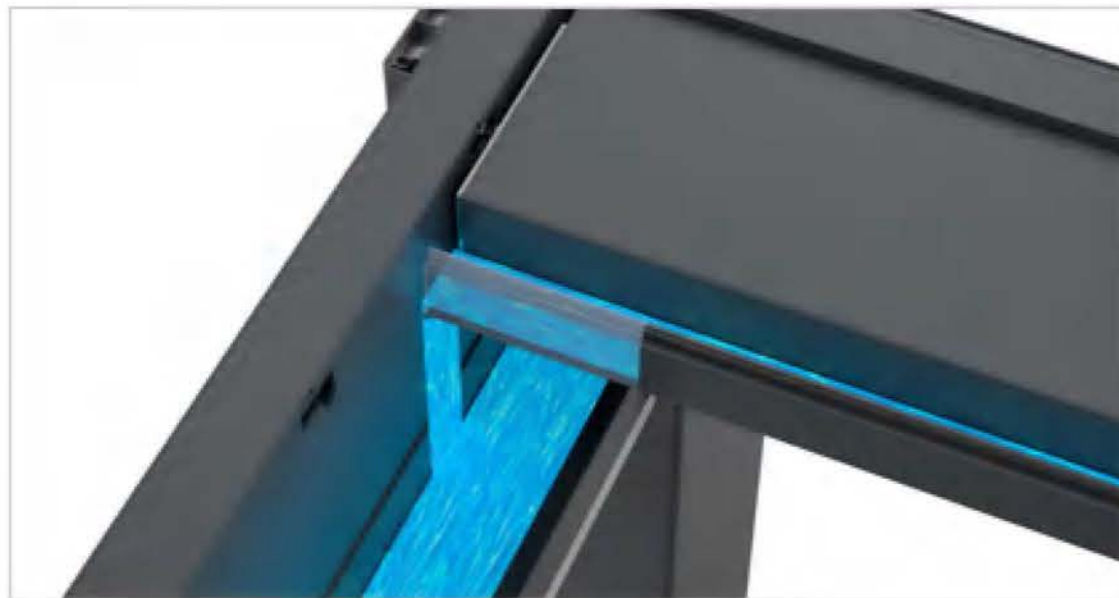

DOUBLE-LAYER BLADES WITH WATER CHANNELS

The blinds feature a dual-layer structure equipped with water diversion channels. Rainwater flows from the blade channels into the inner channels, ensuring that even after heavy rain, when the blinds are opened, water is directed into the channels without any dripping.



ALUMINIUM ALLOY SHUTTER PERGOLA

THIS INNOVATIVE SUNSHADE AWNING OFFERS EXCEPTIONAL SHADING, HEAT INSULATION, RAIN PROTECTION, AND WIND RESISTANCE, ENSURING DURABILITY AND STABILITY.



GARAGE DOOR





GARAGE DOORS

GLASS PERSPECTIVE DOOR / ALUMINUM GARAGE DOOR







ROLL-UP GARAGE DOOR

TO FIND THE BEST SOLUTION FOR EVERY CHALLENGE







DELICATE TORSION SPRING BALANCE SYSTEM



ULTRA-QUIET OPERATION



INVISIBLE ANTI-PINCH, BROKEN BRIDGE JOINT



EUROPEAN STANDARD HARDWARE ACCESSORIES

USER-FRIENDLY DESIGN IN LINE WITH EU EN13241-1 SAFETY STANDARDS

FRONT DOOR SERIES





PIVOT DOORS

ALL DOOR TYPES CAN BE DESIGNED WITH DIFFERENT OPENING METHODS, WITH THE OPENING DIRECTION BEING EITHER LEFT OR RIGHT, AND OPTIONS FOR SIDE PANELS, GLASS, OR TOP WINDOWS.



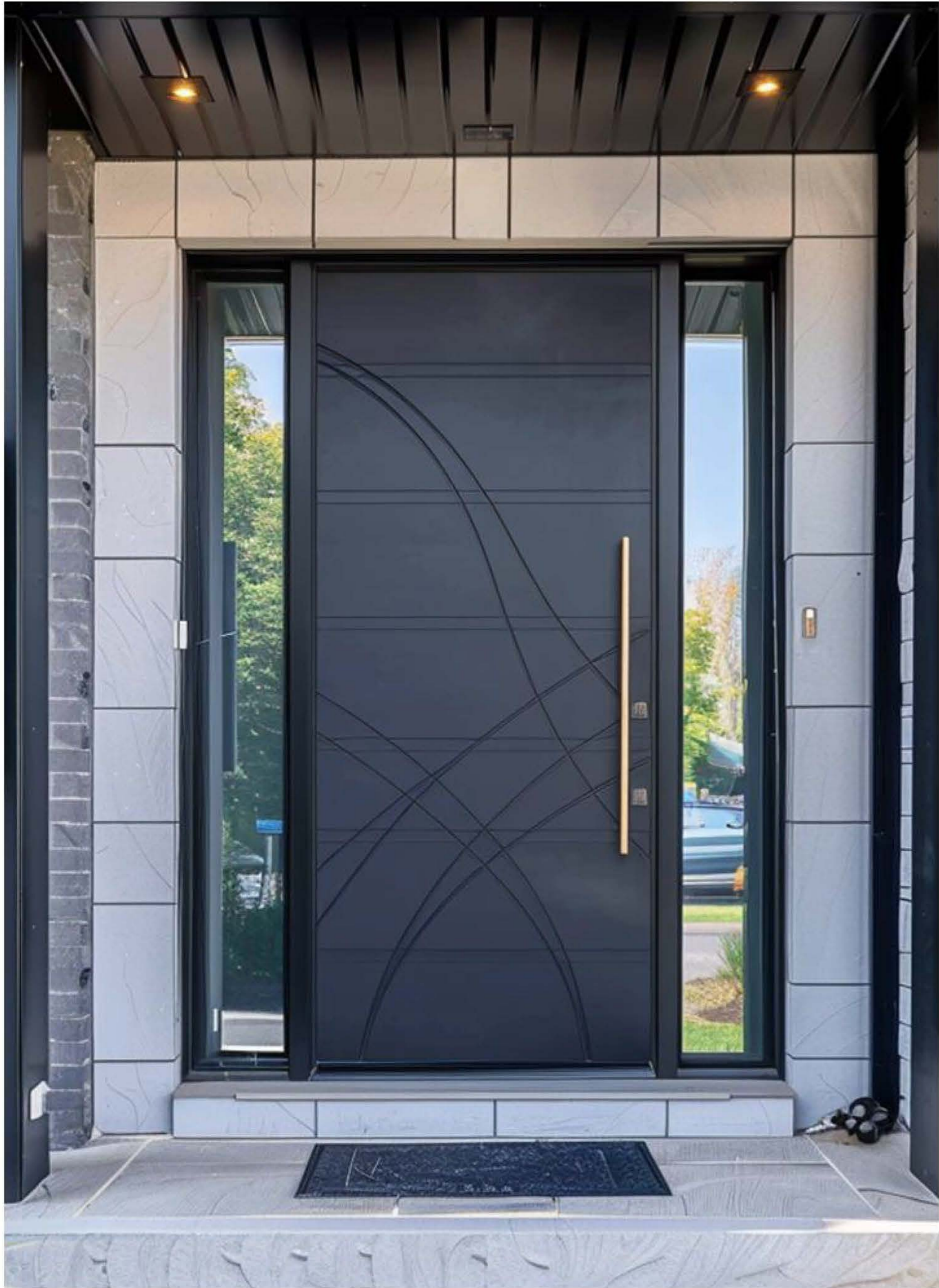



IN-SWING ENTRY DOOR

BEAUTIFUL ATMOSPHERE, ENHANCE TASTE: A VARIETY OF STYLES,
COLORS TO CHOOSE FROM, SIMPLE AND MODERN, ELEGANT
EUROPEAN STYLE, THERE IS ALWAYS A PERFECT FIT WITH YOUR
HOME STYLE, HIGHLIGHT YOUR EXTRAORDINARY TASTE.

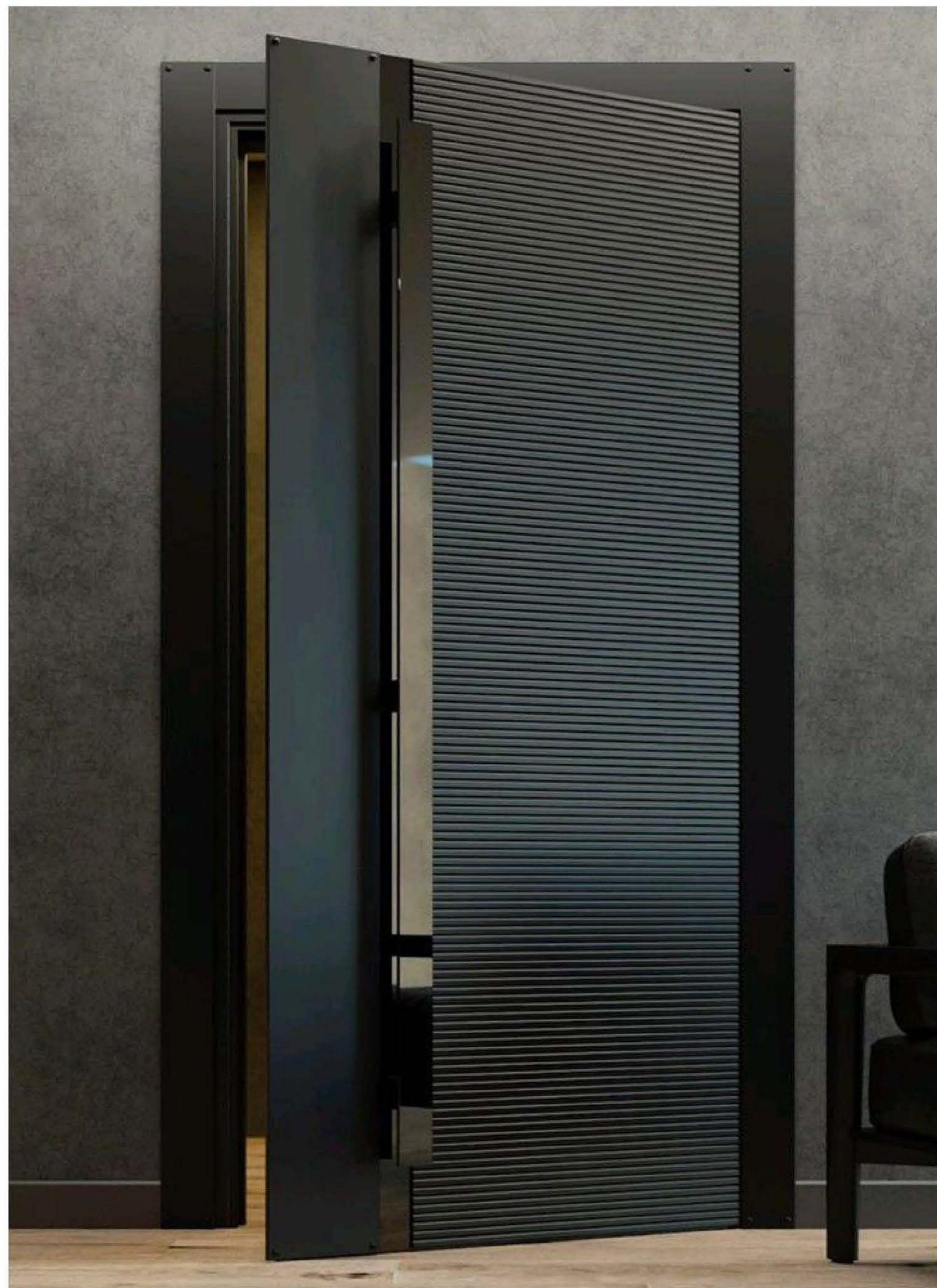
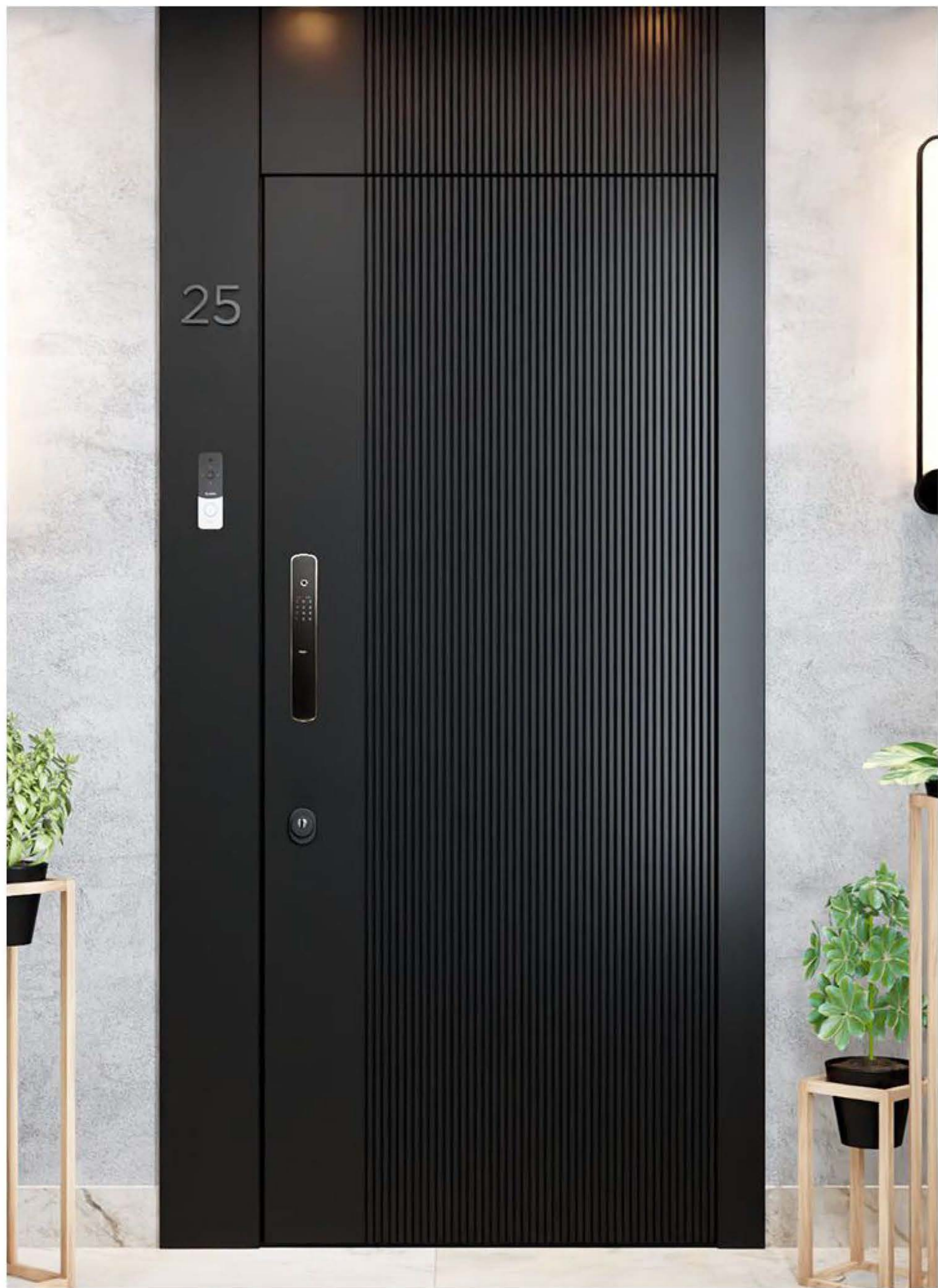

SUNSHADE PRODUCT SERIES



WINDPROOF ZIPER BLINDS

Windproof curtain is the latest popular windproof sunshade and rain products, which can be applied to: high-end hotels, home balconies, windowsills, pavilions, sunrooms and other places; And can realize the balcony window sealing, partition, wind and rain shading functions.



PRODUCT PARAMETER

Size Limitation

The widest 7 meters, the highest 8 meters;
Manual model: The narrowest can do 800mm
Electric model: The narrowest can do 700mm

Finished Product Delivery

Windproof roller blinds are assembled, tested, and then shipped with motors and covers packaged together, and tracks packaged separately.

PATTERN CUSTOMIZATION







SOLAR WINDOWS SUNSHADE (Manual operation)

Make Windows And Doors Smart



PRODUCT PARAMETER

Profile Configuration

Aluminium Magnesium Alloy

Blade width

12.5MM / 16MM

Glass Configuration

5+27A+5mm Tempered Insulated Glass

Blade thickness

0.18MM / 0.2MM

BUILT IN FIXED CELLULAR GLASS

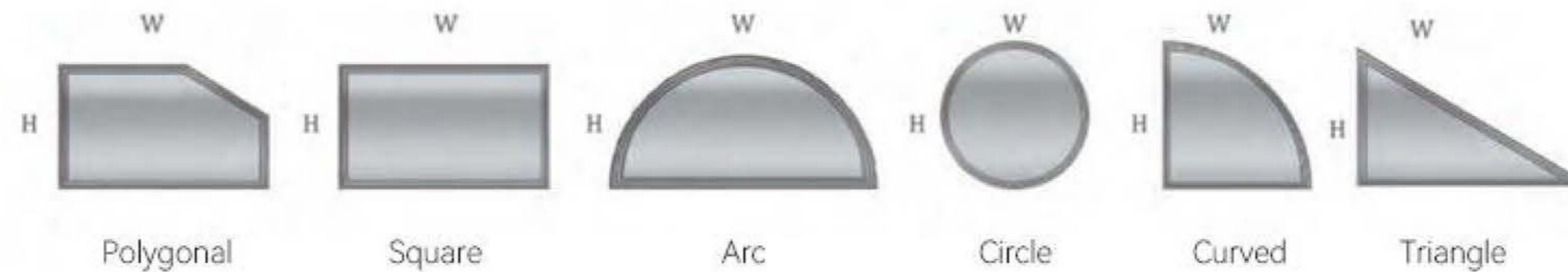

COLOR CUSTOMIZATION

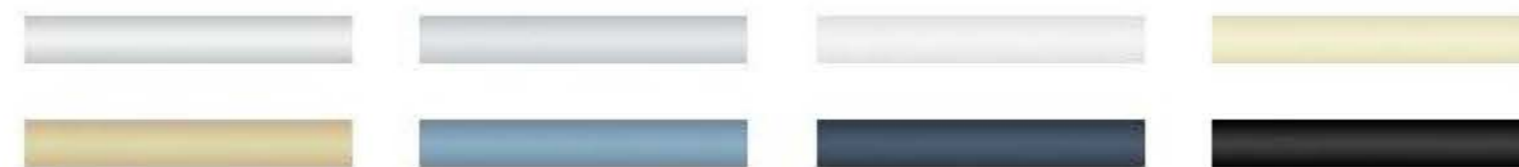

SOLAR WINDOWS SUNSHADE(ELECTRIC)

Make Windows And Doors Smart



PRODUCT PARAMETER

Interior Glass / Exterior Glass Thickness
4 / 5 / 6 / 8 / 10MM

Category
Tempered / Laminated / Fire-Rated Glass

Max [mm]
2800W 3000H

Min [mm]
430W 300H

Area [m²]
Max ≤ 6

BUILT IN FIXED CELLULAR GLASS

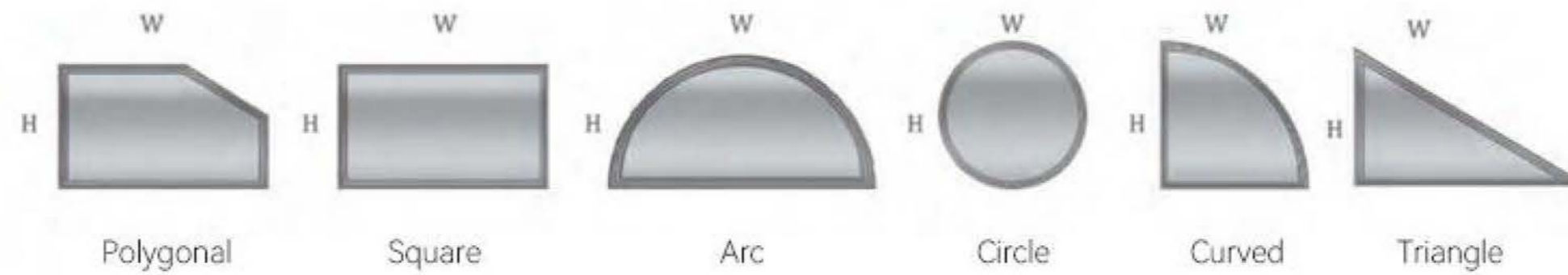

COLOR CUSTOMIZATION





FOLDING PVC PERGOLA

Folding canopy is a new outdoor space expansion scheme. Special curtain through the motor drive belt movement in the aluminum alloy track, so as to achieve the opening and closing of the curtain, so that users freely enjoy the fun of outdoor space, while providing the function of shading and rain, replacing the traditional fixed ceiling awning and sun room, redefine the solution of outdoor space.



PRODUCT PARAMETER

Material

6063, aluminum alloy

Color

Black grey/white, special customizable

Cross Bar Interval

450-500mm

Lamp Strip

Silicone waterproof, 3000k brightness LED

Motor

Import, domestic optional, two years warranty

Dimension

The maximum width of a single set is 5m, 7m out

Rain Protection

Complete rain protection

Surface

High density powder coating, anodized

Windproof

Maximum resistance to Force 7 wind, 50-62km/h

Cloth

Heavy PVC, imported domestic optional



INCLINED PULL ROD HOISTING TYPE

LIFTING WITHOUT COLUMNS, DOES NOT OCCUPY GROUND SPACE
DO NOT DAMAGE THE ORIGINAL LANDSCAPE DESIGN
ADJUSTABLE INCLINATION





COLUMN SUPPORTED TYPE

VCONVENIENT INSTALLATION, STABLE STRUCTURE, AND WIND PROOF ROLLER SHUTTER, ALUMINUM SHUTTER, SLIDING DOOR WINDOW, ETC. CAN BE INSTALLED AROUND.SUITABLE FOR VILLA COURTYARDS, ROOFTOPS, TERRACES, OUTDOOR SWIMMING POOLS, OUTDOOR DINING, AND OTHER SPACES

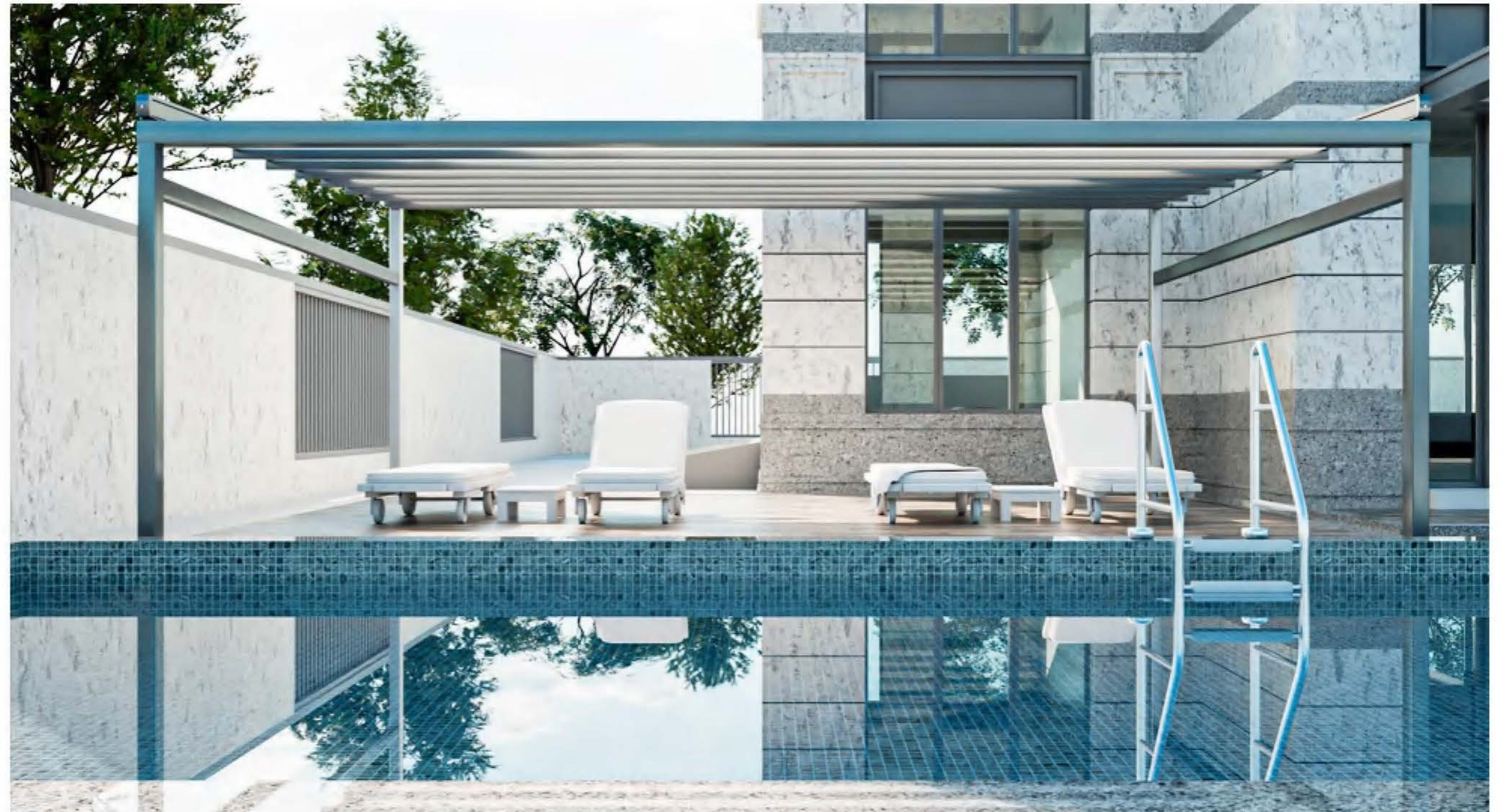



WALL SUPPORT TYPE

DOUBLE COLUMNS SUPPORTED AGAINST THE WALL, EXTENDING CONTINUOUSLY
IN SPACE
SUITABLE FOR HIGH-RISE TERRACE, OUTDOOR RESTAURANT, VILLA COURTYARD





STEEL STRUCTURE SUPPORT HOISTING

SUITABLE FOR LARGE-SCALE OUTDOOR DINING, OUTDOOR ACTIVITY VENUES, AND TEMPORARY CONSTRUCTION OF VENUES
SPACE APPLICATIONS SUCH AS MARKETING EXHIBITIONS, PRESS CONFERENCES, WEDDING BANQUETS, FACTORY BUILDING EXPANSION, BUILDING ROOMS AND CORRIDORS



GLASS FENCE SERIES

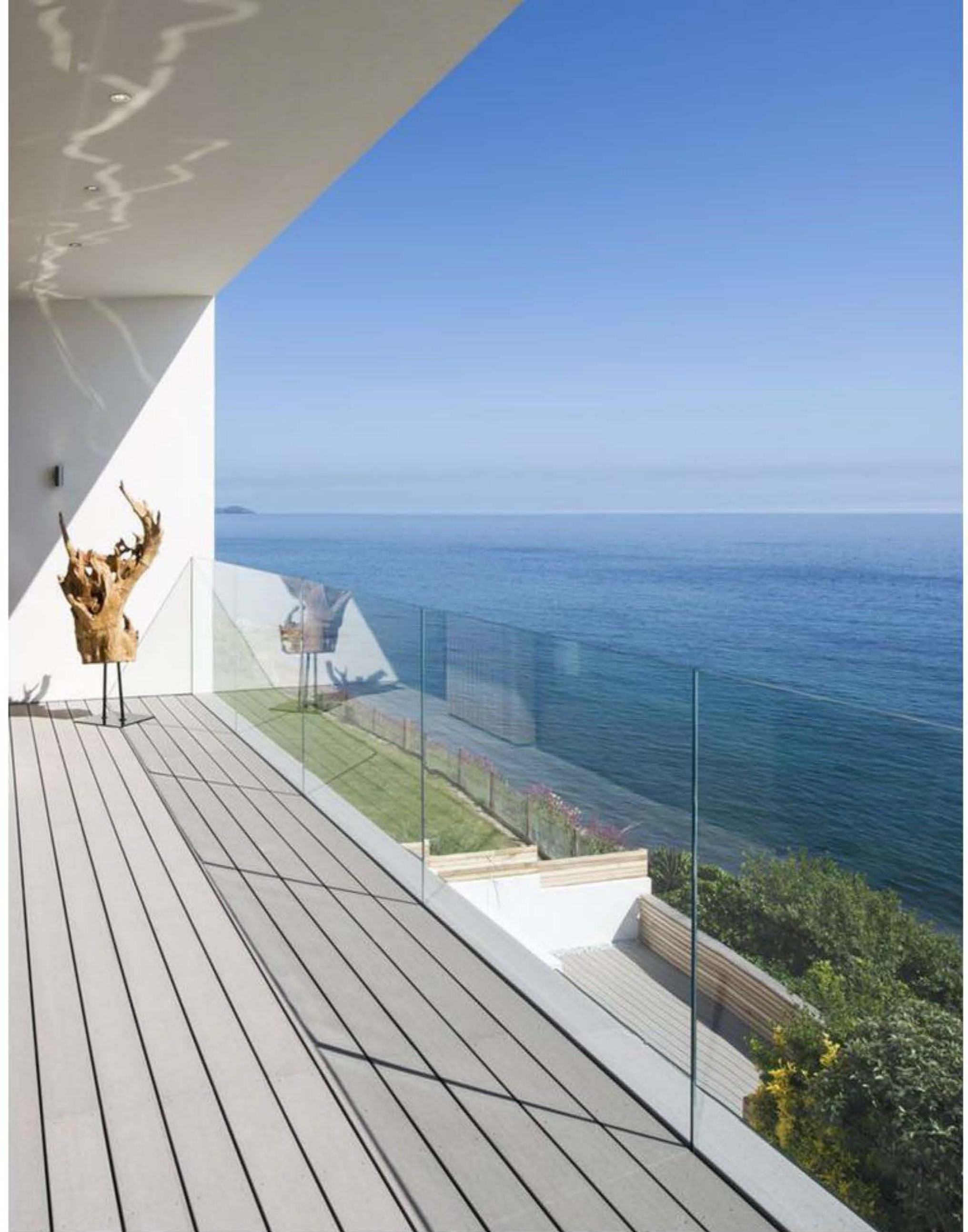

106*65 SERIES

EXPOSED INSTALLATION CAN BE USED FOR SPANS UP TO 6 METERS, WHILE EMBEDDED INSTALLATION CAN BE USED FOR SPANS UP TO 10 METERS

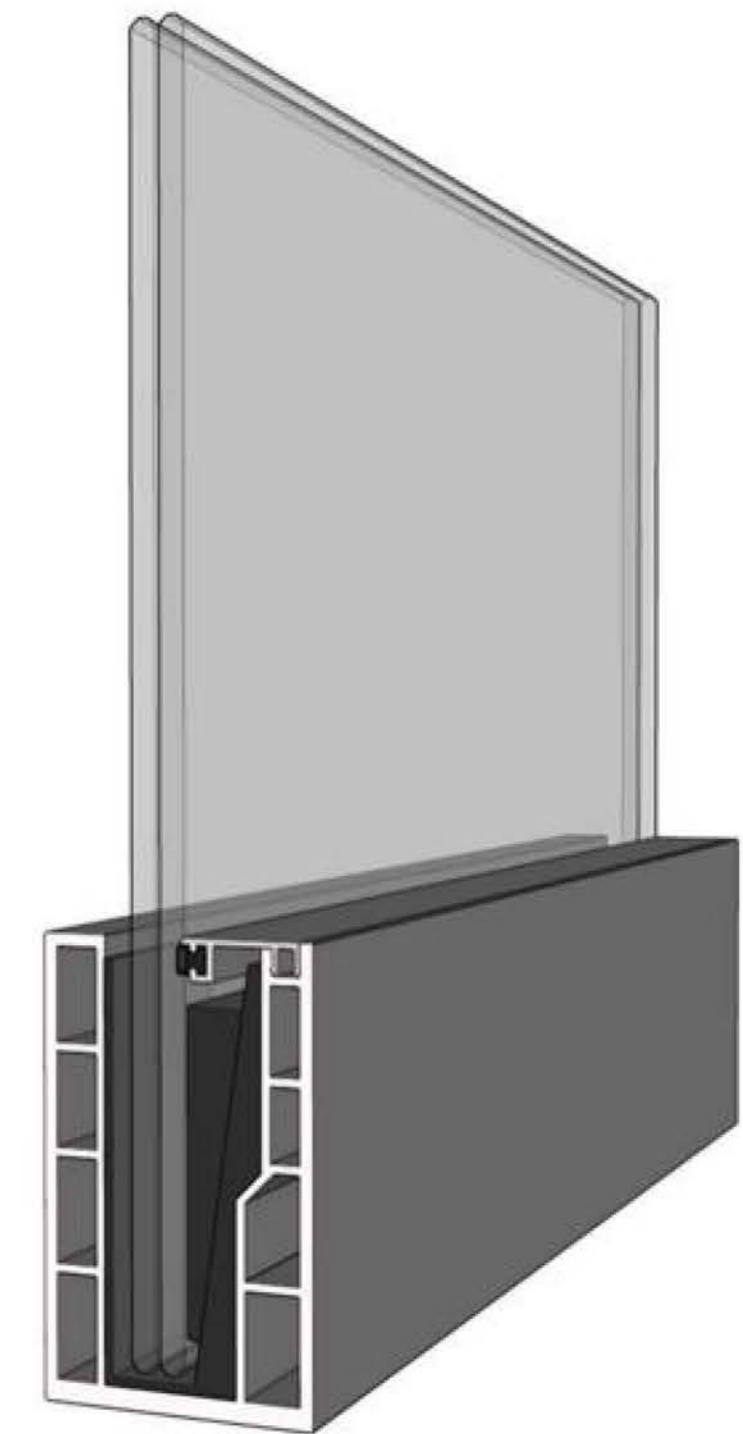
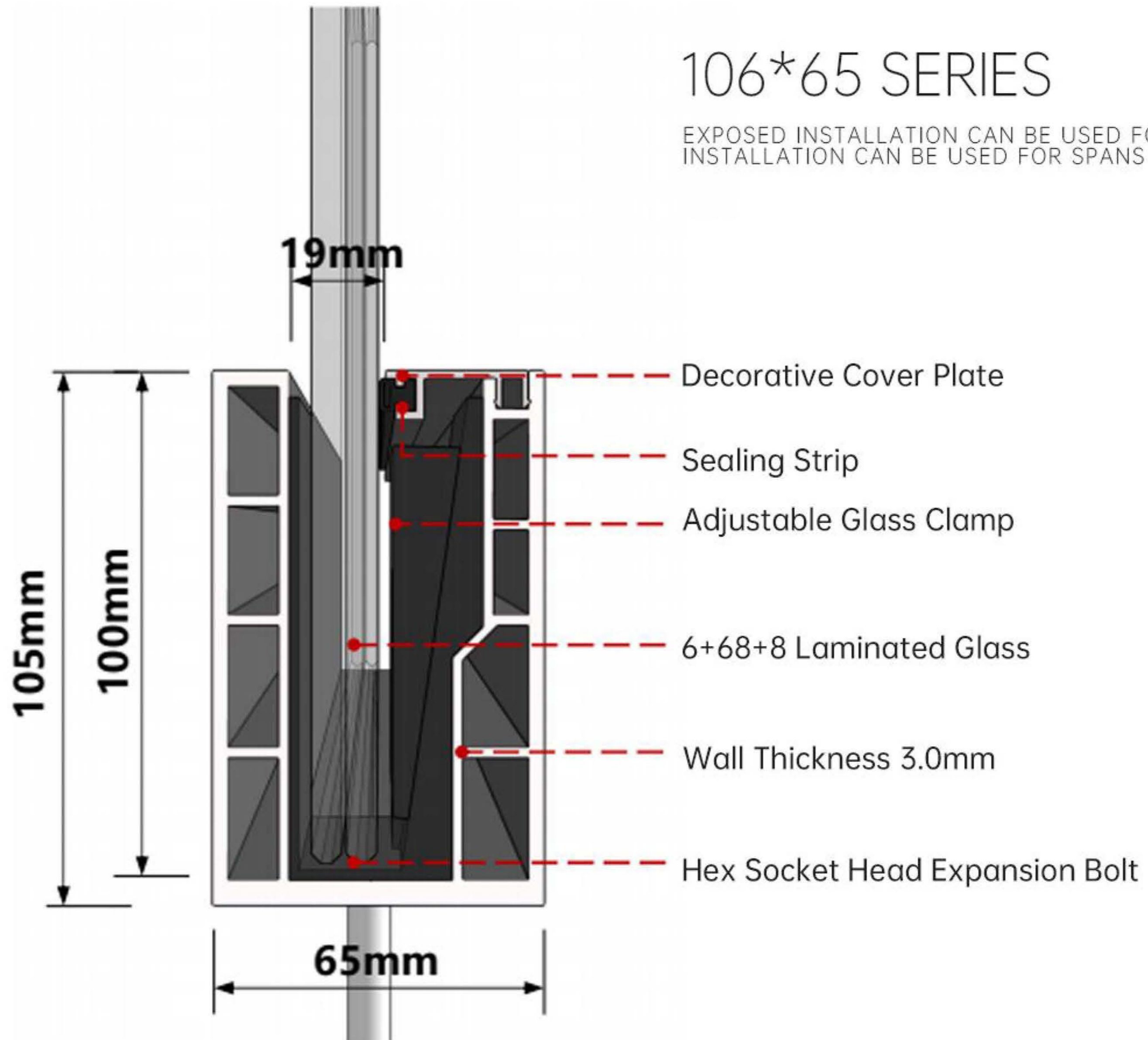

110*96 SERIES

XPOSED INSTALLATION CAN BE USED FOR SPANS EXCEEDING 10 METERS

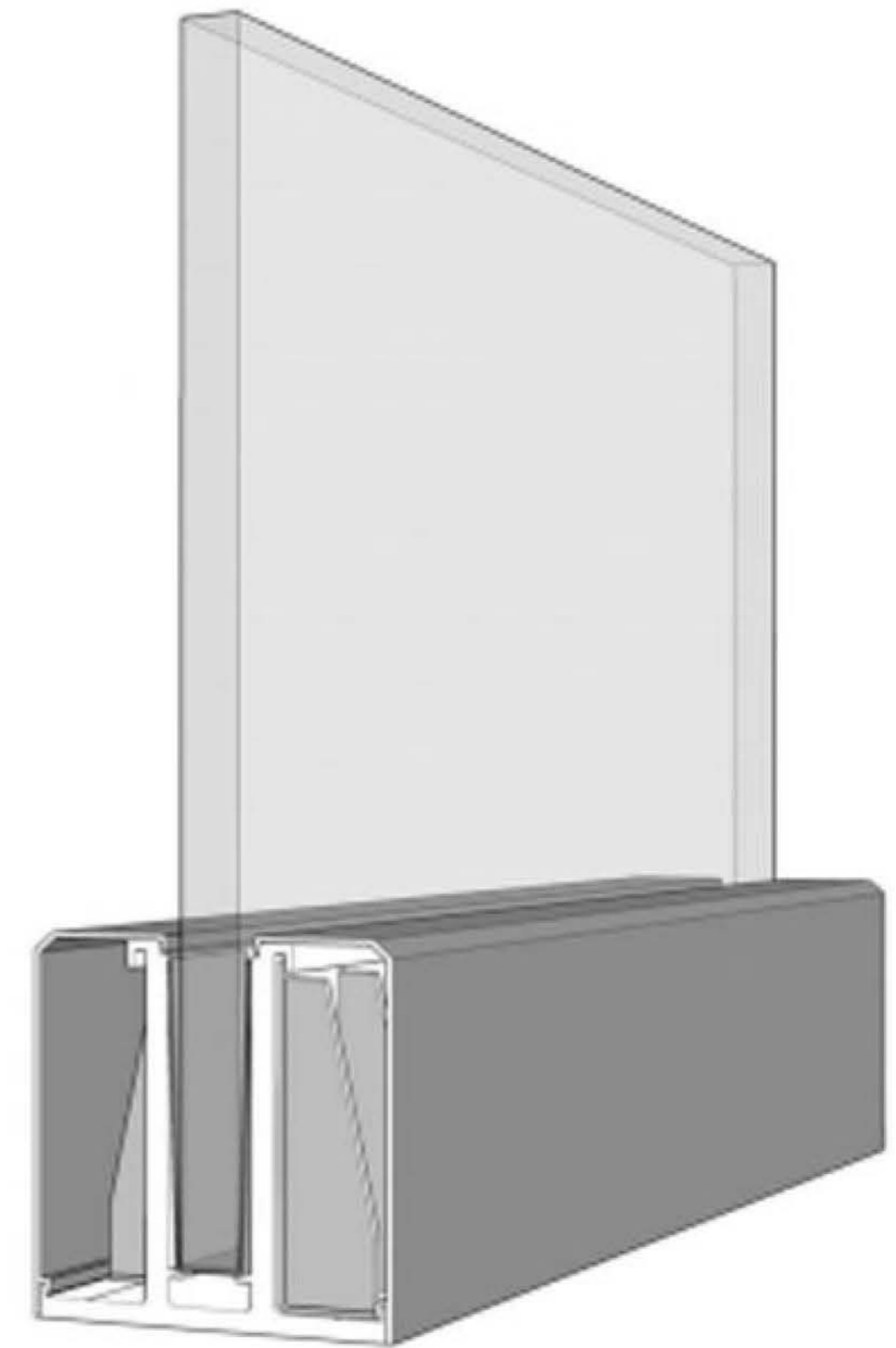
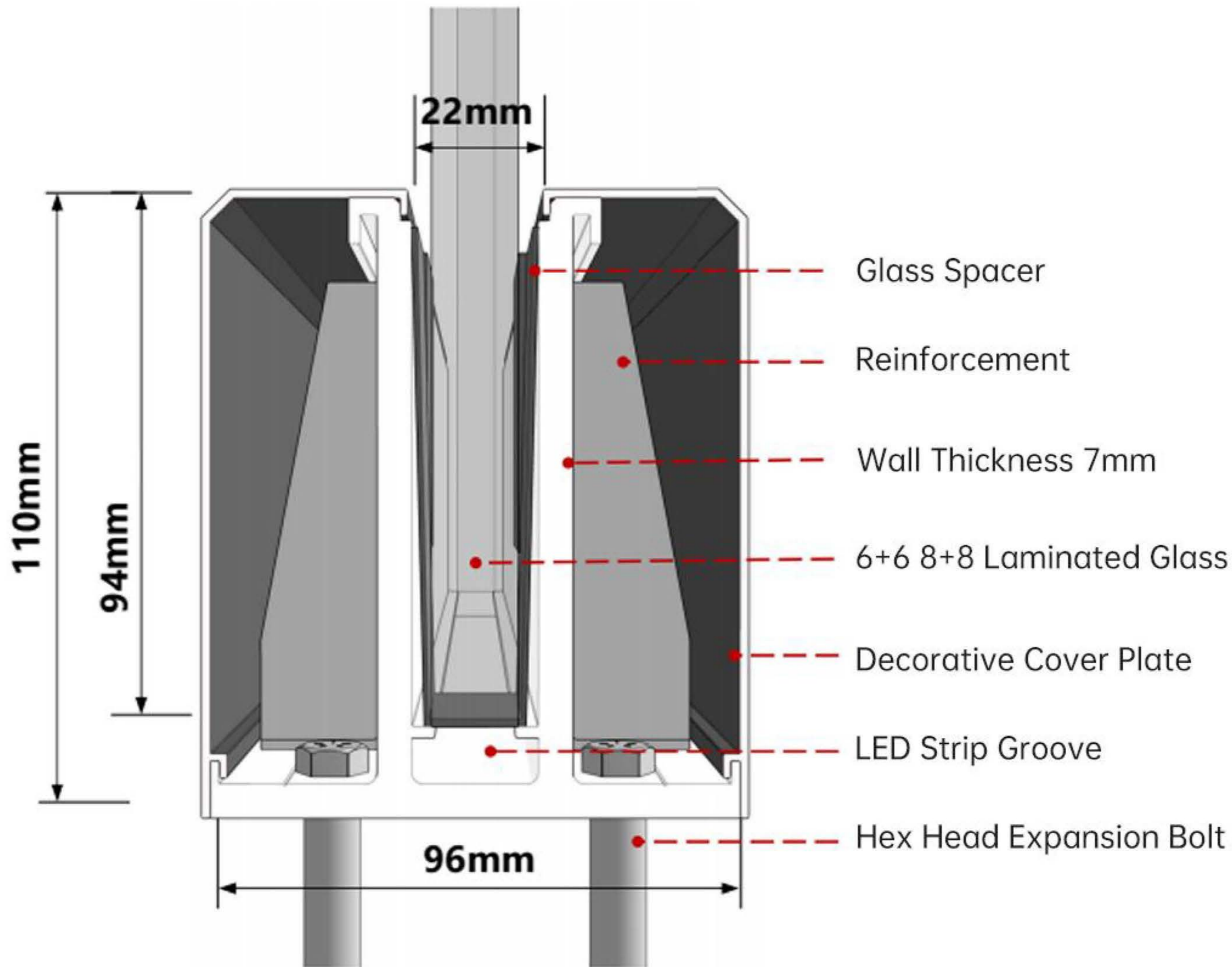

105*42 SERIES

SUITABLE FOR SPANS OF 6 METERS TO 12 METERS

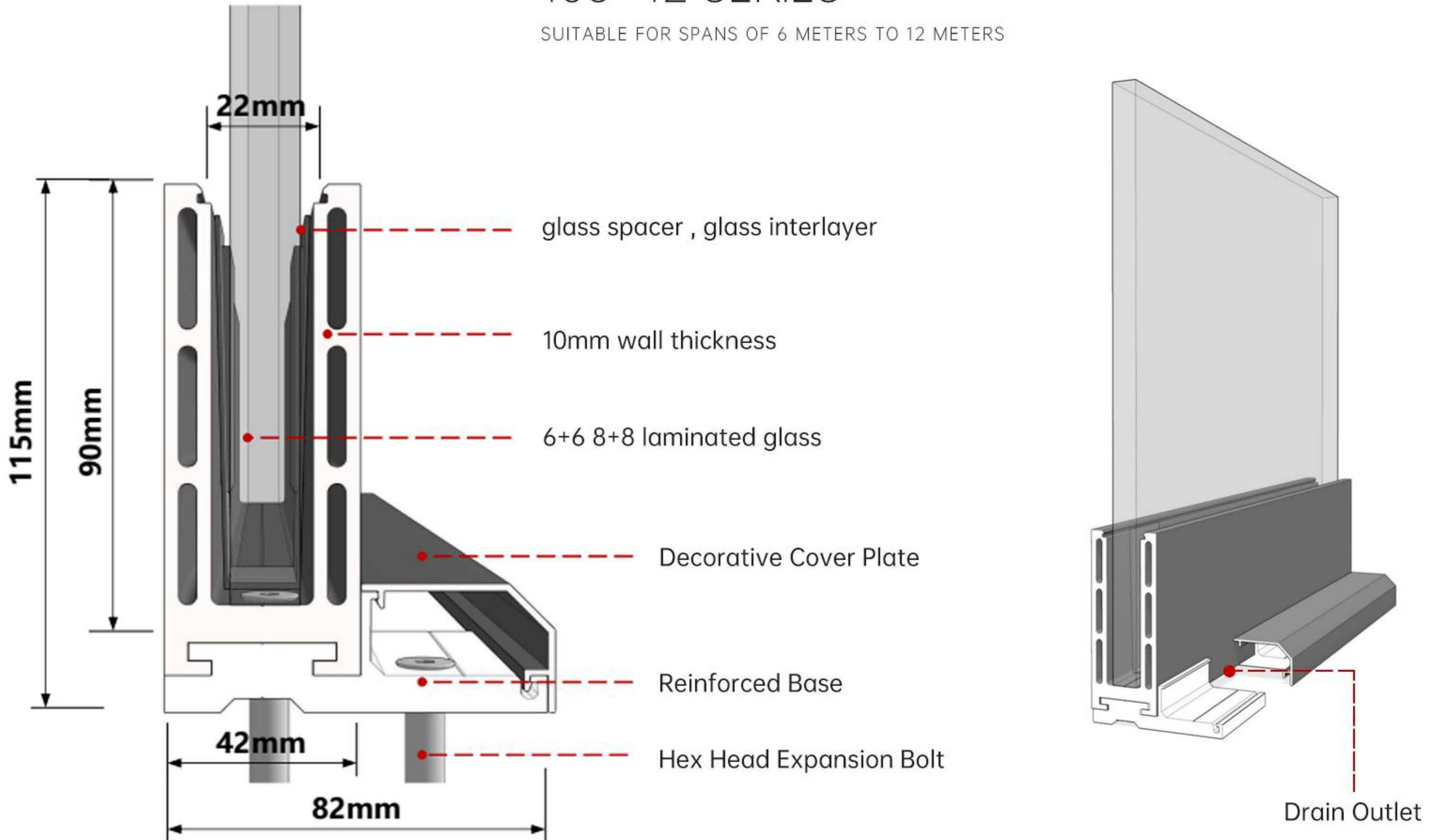



GLASS FENCE

DESIGN IS SEEN IN THE WHOLE, FULLY HIDDEN IN THE DETAILS,
EXPLORING THE DETAILS WITH CARE,
AND TOUCHING THE INHERENT QUALITY

COOPERATIVE PARTNER

DOORS AND WINDOWS

GU
GRETSCH-UNITAS

**Roto**

HOPPE 

wehag

CMECH

杜亚 **DOOYA**
TUBULAR MOTOR

HANS 汉狮

台玻集团

 **XUG**
信義玻璃

Sobinco
OPENS YOUR LIFE

STAFORCE

HOPO

 **VBH**
Everything simple.
Simply everything.

SIEGENIA
brings spaces to life

PAS-Mark

HARDWARE ACCESSORIES

CMECH



HOPPE



G-U



SIEGENIA



KIN LONG



PANASONIC



GLASS OPTION

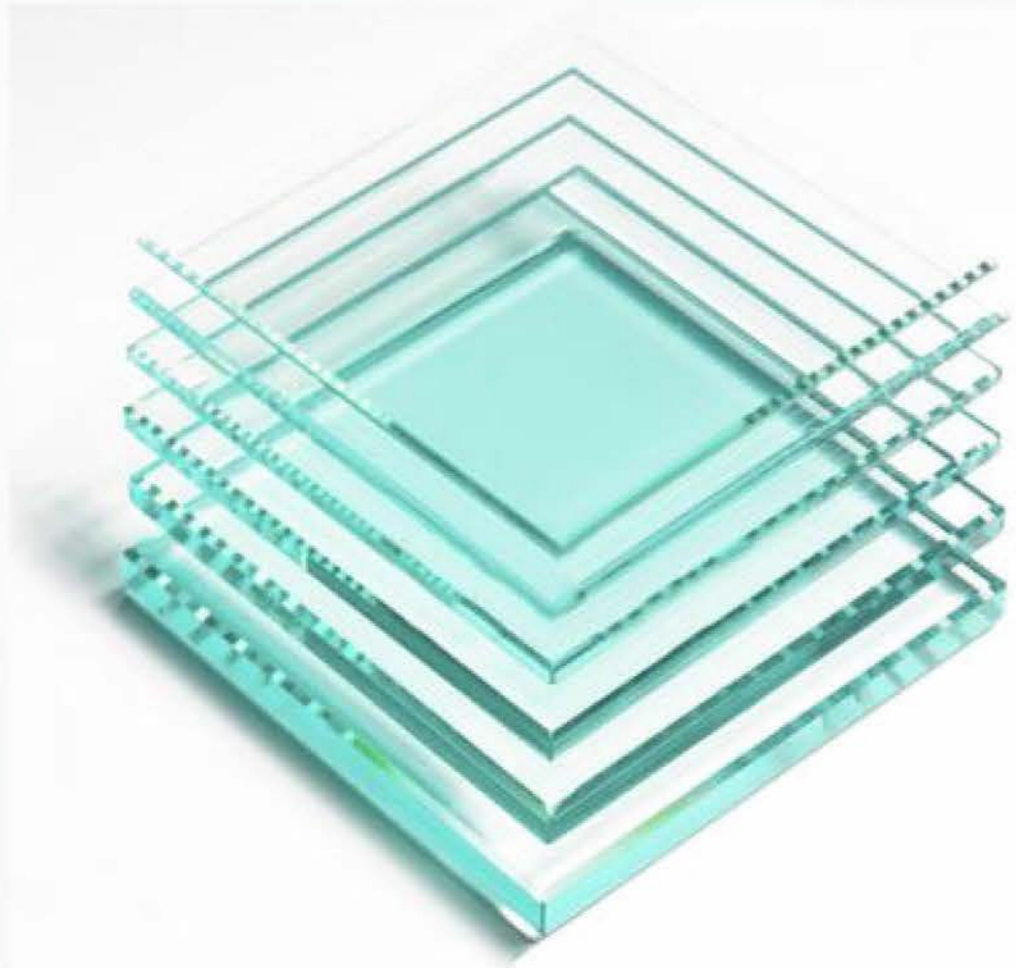

TEMPERED GLASS

The impact strength is 3 to 5 times that of ordinary glass, and when the glass is destroyed, the fragments will become honeycomb-like small obtuse particles, which is not easy to hurt people



LAMINATED GLASS

It consists of two or more pieces of glass sandwiched with one or more layers of organic polymer intermediate film. Laminated glass has good safety, even if broken will not be scattered, can effectively prevent personnel injury. At the same time, it also has a certain sound insulation, heat insulation properties

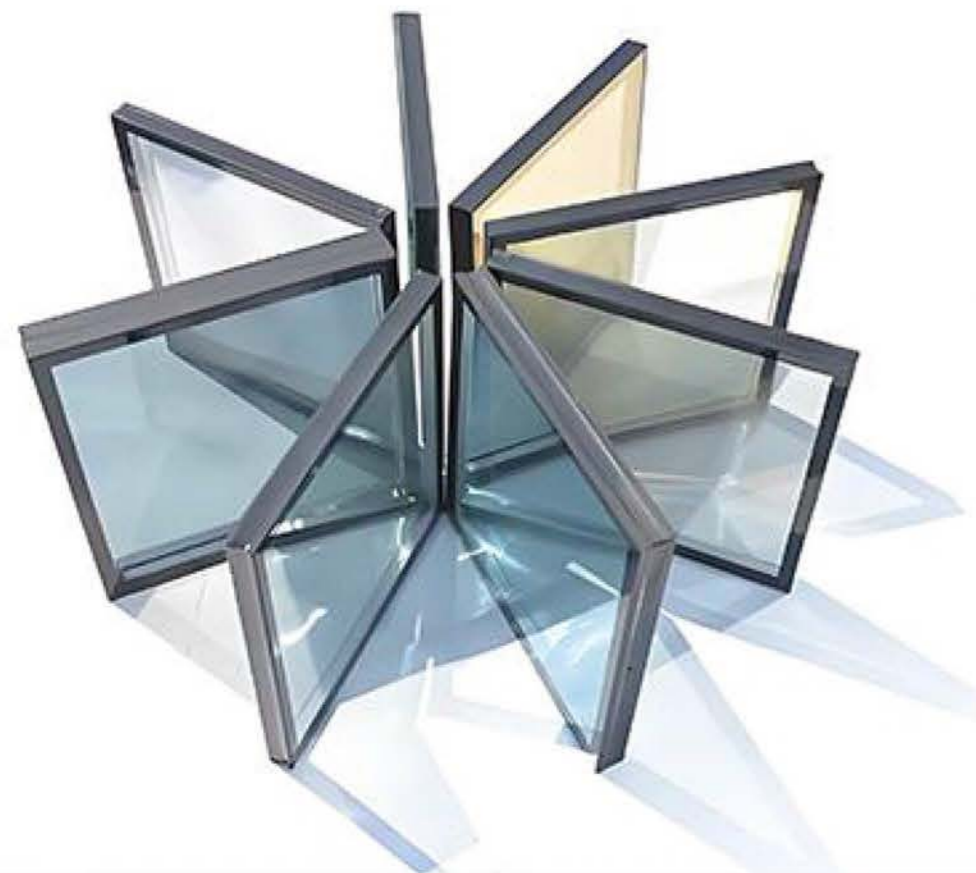

LOW-E GLASS

Anti-ultraviolet, with heat insulation, heat preservation effect. According to the light transmittance, it is divided into Low, medium and high transmittance low-E

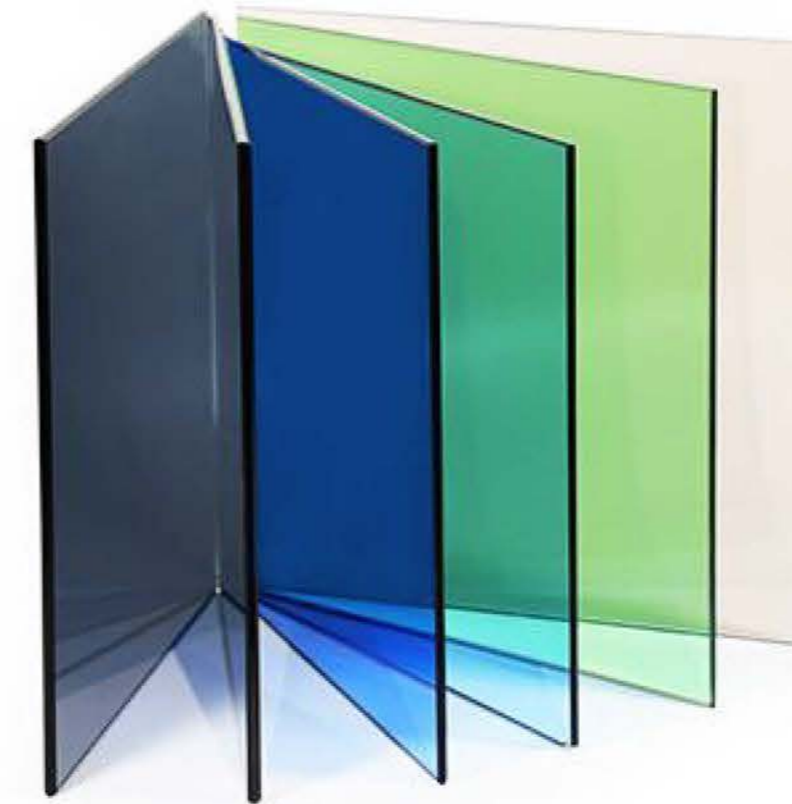

TINTED GLASS

Colored glass is coated with metal oxides or organic matter, which can change the color and light transmission of the glass. It can not only block UV rays, reduce the fading of indoor furniture and decorations, but also improve indoor privacy.

GLASS OPTION



DIMMING GLASS

Dimming glass can be controlled by electric control, temperature control, light control, pressure control and other ways to achieve the transparent and opaque state of the glass switch.

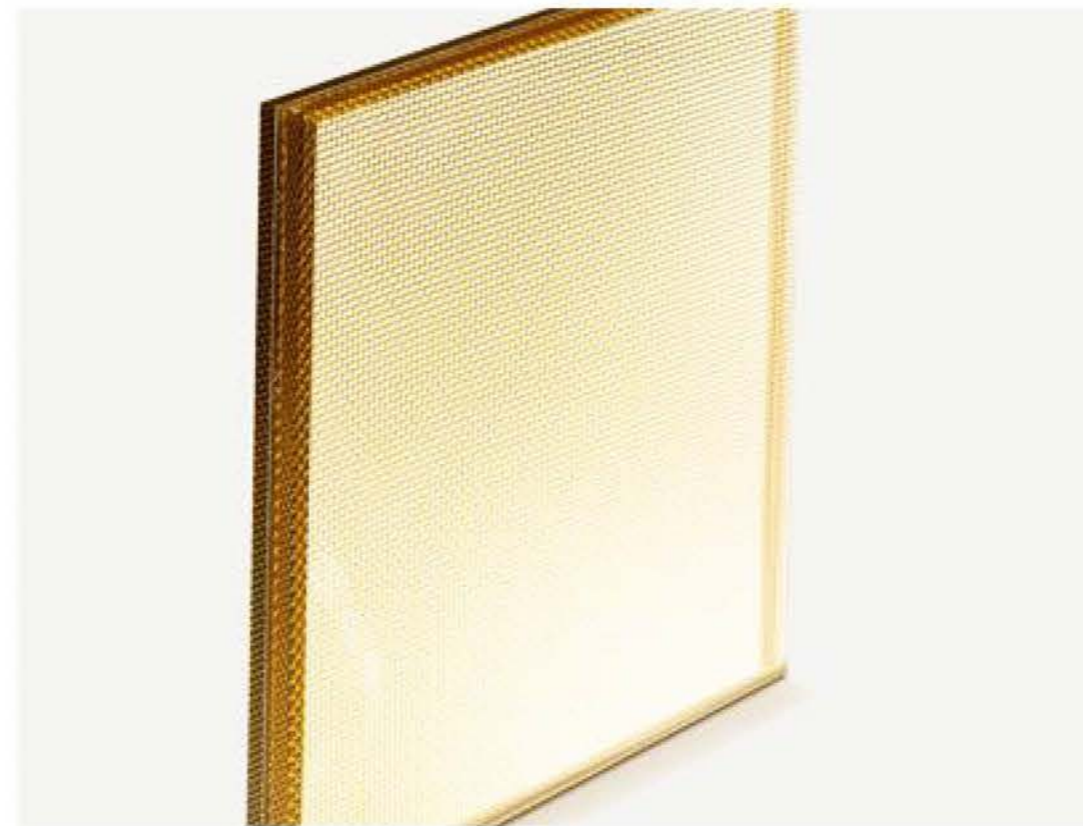

AMBERINA

Art glass has a unique appearance and fine texture, which can significantly enhance the beauty of interior decoration and improve the privacy of the interior.

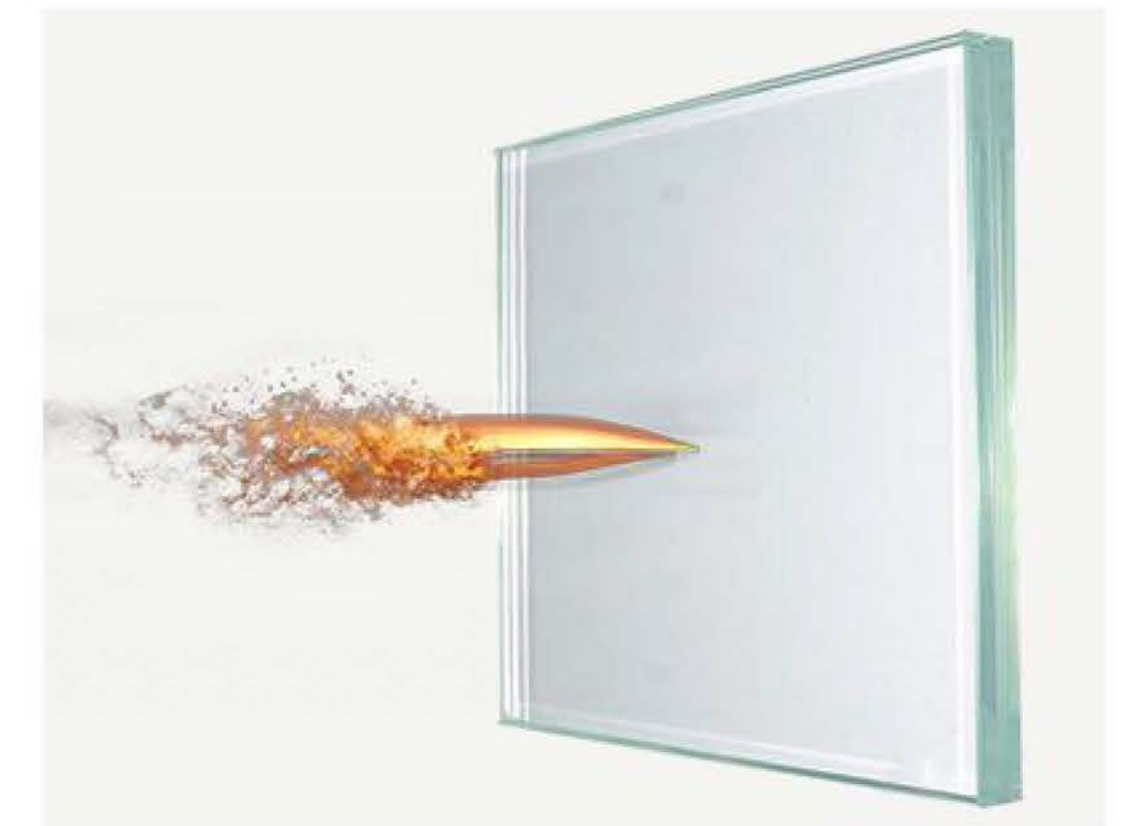

BULLETPROOF GLASS

Bulletproof glass not only has the light transmission and image transmission performance of glass, but also has the protection ability of bullet shooting glass. The bulletproof principle of bulletproof glass is that it can convert the impact kinetic energy of the bullet into the elastic potential energy of the glass and the surface energy of the fragment.

STANDARD COLOR CHIPS



METALLIC GREY



DEEP SKIN



METALLIC COFFEE

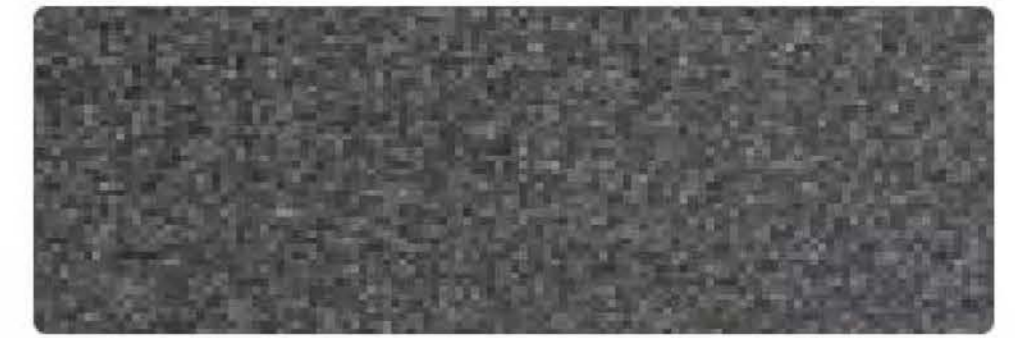

MELANITE



FAIR SKIN



CHOCOLATE BROWN



SIGNAL BROWN



MOSS GREY



RUBY RED

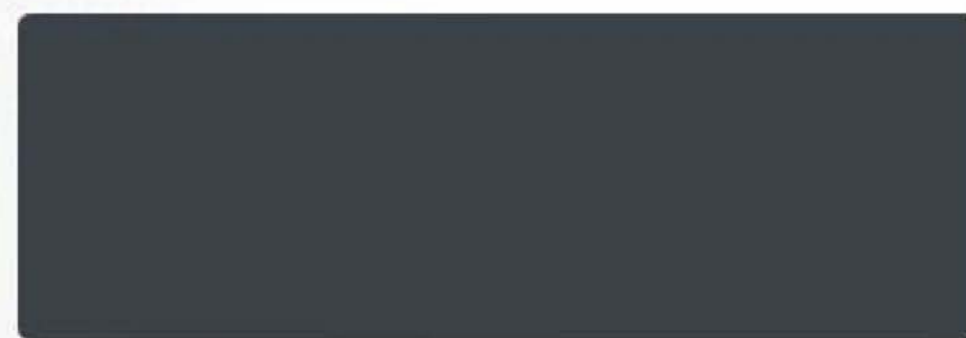

BLUE GREY



LVORY



PASTEL BLUE

SCREEN

Screen Styles: Fixed Fly Screen, Sliding Fly Screen, Rolling Fly Screen, Retractable Fly Screen;
Materials Options: Fiberglass / 304 Stainless Steel / Aluminum

